

Handbook on Mass Flow Meter Training Course

Strengthening Legal Metrology Infrastructure
for Trade Facilitation(CTI 46/2009T)



Asia-Pacific
Economic Cooperation



Asia-Pacific
Legal Metrology Forum



July 6–9, 2010
Singapore

A
P
E
C

APEC Secretariat

35 Heng Mui Keng Terrace

Singapore 119616

Tel:+65-6891-9600, Fax:+65-6891-9690

E-mail: info@apec.org

Website: www.apec.org

APLMF Secretariat

General Administration of Quality Supervision, Inspection and Quarantine(AQSIQ)

No.9 ,Madiandonglu,Haidian District,Beijing,100088,P.R.China

Tel:+86-10-82260335, Fax:+86-10-82260131

E-mail:aplmf@aqsiq.gov.cn sec@aplmf.org

Website: www.aplmf.org



Asia-Pacific
Economic Cooperation



Asia-Pacific
Legal Metrology Forum

Handbook on Mass flow Meter Training Course

Strengthening Legal Metrology Infrastructure
for Trade Facilitation
(CTI 46/2009T)

July 6 – 9, 2010

Singapore

APEC Secretariat

35 Heng Mui Keng Terrace

Singapore 119616

Tel: +65-6891-9600

Fax: +65-6891-9690

E-mail: info@apec.org

Website: www.apec.org

APLMF Secretariat

Department of Metrology, AQSIQ

No. 9 Madiandonglu, Haidian District, Beijing, 100088, P. R. China

Tel: +86-10-8226-0335

Fax: +86-10-8226-0131

E-mail: sec@aplmf.org

Website: www.aplmf.org



Group photo

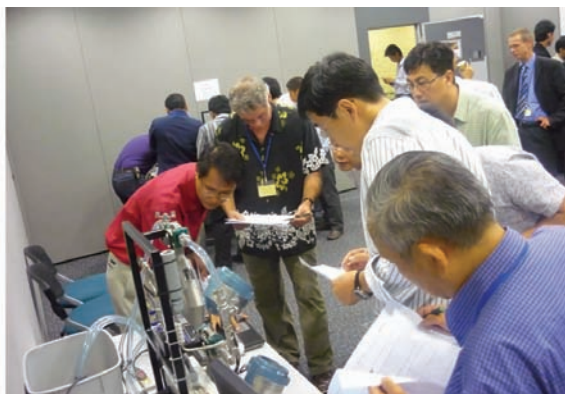

Photos taken during the training course

Contents

1 Foreword	1
2 Summary Report	3
3 Program	6
4 Participants List	11
5 Lectures (By Mr. Wim Volmer and Mr. Aart Pruysen)	
5.1 Coriolis—direct mass metering by Wim Volmer (NMI, Netherland)	15
5.2 Practical session on Coriolis Meters by Wim Volmer (NMI, Netherland) and Aart Pruysen (Emerson)	45
5.3 Route to OIML compliance of Micro Motion for marine applications by Aart Pruysen (Emerson)	64
5.4 Technical explanation on Coriolis meters by Aart Pruysen (Emerson)	77
6 Overview of the Measurement System and Current Situation about Mass Flow Meter in Member Economies	
6.1 Overview of the Legal Metrology System on Mass Flow Meter in China by Mr. Gong Lei (ChongQing Academy of Metrology and Quality Inspection, P. R. China)	97
6.2 Overview of the Legal Metrology System on Mass Flow Meter in Indonesia by Mr. Henry Gunawan (DOM, Indonesia)	102
6.3 Overview of the Legal Metrology System on Mass Flow Meter in Malaysia Mr. Mohd Noor b. Mohd Ghafar (NML-SIRIM, Malaysia)	105
6.4 Overview of the Legal Metrology System on Mass Flow Meter in New Zealand by Mr Julian Crane (MAPSS, New Zealand)	109
6.5 Overview of the Legal Metrology System on Mass Flow Meter in Peru by Mr. Nikko Meza (INDECOPI, Peru)	111
6.6 Overview of the Legal Metrology System on Mass Flow Meter in Philippines by Ms. Marilyn C. Fos (NML-ITDI, Philippines)	114
6.7 Overview of the Legal Metrology System on Mass Flow Meter in Singapore by Mr. Lim Yong Seng (SPRING, Singapore)	121
6.8 Overview of the Legal Metrology System on Mass Flow Meter in Thailand by Ms. Khemsai Rahannok (CBWM, Thailand)	124
6.9 Overview of the Legal Metrology System on Mass Flow Meter in Viet Nam by Mr. Nguyen Hoang Nam (VMI, Viet Nam)	126

Foreword

This handbook is one of outcomes of the APEC/APLMF Training Programs titled “Strengthening Legal Metrology Infrastructure for Trade Facilitation: Mass Flow Meter” which was held on July 6-9, 2010 at the Holiday Inn Atrium, Singapore.

This course was organized by APLMF secretariat and arranged as one of the APEC TILF projects, CTI-46/2009T. Also, it was supported by SPRING Singapore. I would like to extend my sincere gratitude to staffs of SPRING Singapore for their outstanding preparation and generous hospitality. I also would like to thank two trainers, Mr. Wim Volmer, NMI Certin BV, The Netherlands and Mr. Aart Pruysen, Emerson Process Management, The Netherlands for their excellent presentations. Also, special thanks should be extended to the APEC Secretariat for their great contributions.

Mass flow meters are used in a wide range of industries such as chemicals and petrochemicals and so on. They are also commonly used in the measurement of large quantity in the oil and gas industries. Its application is widely accepted for legal metrology control to ensure accurate measurements between transacting parties and to assist the government in the collection of excise taxes.

This training course on mass flow meters aims to provide participants with a better understanding of the design principle and operation of the Coriolis mass flow meters and the verification of such flow meters in accordance with OIML Recommendation 117 (Dynamic measuring systems for liquids other than water) . The training course included both classroom lectures and on-site demonstrations of conducting a reference test and hands-on practices. This arrangement offered a good opportunity for all participants to enhance the technical capabilities of the participants and ensure a common understanding and interpretation of the OIML Recommendation in line with international best practice.

Due to the great contributions from the trainers and participants as well as the effective collaboration between the SPRING Singapore and APLMF Secretariat, I would like to say that

this training course is certainly a fruitful activity!

Finally, I would like to express my deeply appreciate again to the APEC Secretariat's generosity in contributing to the development in legal metrology among the APLMF member economies.

August 11, 2010

A handwritten signature in black ink, consisting of stylized Chinese characters, likely 'Pu Changcheng'.

Mr. Pu Changcheng

APLMF President

Summary Report

Introduction

This document is intended to describe the common observations of the trainers:

Mr. Aart Pruysen, Emerson Process Management, The Netherlands

Mr. Wim Volmer, NMI Certin BV, The Netherlands

with regard to the training conducted in Singapore July 6-9, 2010 on Coriolismeters in legally controlled applications.

Given the nature of the report, please be aware it is of a subjective nature, representing the feelings/opinions of two persons only.

Both Mr. Pruysen and Mr. Volmer were independently asked by APMLF to act as trainers on above mentioned course. Communications between APMLF and both trainers was done via E-mail, thus providing input for the both of them for their preparations.

The trainers used telephone, E-mail and a one day meeting to coordinate their preparations/presentations.

Trainers' assumptions

Based on previously described communications, both trainers expected to be conducting training to an audience mainly consisting of Weights and Measures (related) participants from the APMLF Members having a basic knowledge of mathematics, flow metering and OIML Recommendation R117 – 1. Thereby consequently assuming only needing to focus on aspects particular to Coriolis mass flow meters, from both a technical and legal perspective.

Note#1: Both trainers were aware of bunkering related issues in Singapore.

Note#2: Both trainers are aware of the fact that in the majority of Asian cultures it may not be not customary to interrupt trainers with questions or be confident about speaking in public.

Trainers' preparations

Both trainers have conducted training courses before and firmly believe in an approach where topics are being dealt with in at least two and preferably three different manners (e. g. news-reader first saying what he is about to tell, then tell it and then summarise what he just told). In a similar fashion it was jointly decided to first approach matters from the technical side, then the legal side, followed by the practical side.

Linguistic remarks

For both trainers English is not their native language, nor is it for the overwhelming majority of participants. Overall we feel this is an advantage in this case, since the trainers therefore do not “rattle away” as some native speakers might have done. However, the language barrier

may have held back responses from some participants who potentially do not feel comfortable about speaking in public, in a strange language. This on top of potential cultural reservations.

Day-by-day evaluation

Tuesday (July 6) was dedicated to presenting the participants with the technical theoretical background for understanding the operation of Coriolis mass flow meters. Both presenters agree the contents reflect what is needed for understanding consequences for all three levels of legal metrology: Type Approval, Initial Verification and Inspection.

Both trainers have the feeling that this was too much in too little time to grasp for some of the participants.

Wednesday (July 7) exclusively dealt with defining the relationship between the technology and the applicability of legal requirements as a logical consequence of that.

Again, both trainers felt the essence of their message had not fully caught on yet.

Thursday (July 8) was felt to be the turnaround day (with thanks to the Emerson Singapore staff). The hands-on section gave many of the participants the “this is what it means to me” insight. This is derived mostly from informal “evaluations” done on the spot.

Moreover, the changeover from sitting-and-listening to seeing-and-doing was highly appreciated by the participants. In other words, we strongly recommend including practical sessions in any future training course.

Friday (July 9) consisted out of two parts.

The first part was a visit to the National Metrology Centre where various Singapore National Standards were visited and admired. Although not all of them were directly relevant to Coriolis metering, it did connect well with the professional interest of the participants and trainers. As such, it was generally considered to be a switch from the school benches to practice.

Friday’s second part comprised two elements key to any training: a closing question and answers session and the official closure of the event. After a hesitant start, the questions and answers session went pretty much as desired. This confirmed the trainers in their opinion that the course’s key topics were comprehended by the majority of participants.

The closing ceremony, with attention to both the formal side and the partly informal manner it was conducted in, was experienced as something that will enable participants to contact each other on an equal basis on matters of common interest.

Objectives and results

Coriolis meters are generally considered to be not the easiest of measurement instruments, neither from a technical point of view, nor from a legal one.

Having set out on the goal of providing a common basis of knowledge and understanding, both trainers feel they have succeeded in that. At the same time both had hoped to transfer more of their knowledge and experience than they now feel they did. In subjective terms the conclusion from our side is that the result is the best that could be hoped for, given the available time.

We both think the participants will have less restraint to contact one another in case of questions/doubts, since they now operate from an identical level of knowledge, strengthened by a kind of social bond created by participating in both the formal and social parts of the course.

Observations regarding the participants

From a trainer's point of view the participants formed a difficult group to perform for, because their background and key-interests varied widely. At the same time they were polite and considerate towards both the other participants as the trainers. Overall the degree of variation was experienced as a surprise, but their consideration and attitude was highly appreciated.

Observations regarding the Organisation

Both trainers experienced the overall organisational aspects as a somewhat unexpected mix of extremely-well-organised and left-up-to-on-the-spot-improvisation. Since both trainers are experienced public speakers, this last aspect was not felt to be an issue of any sorts. Moreover, it is not expected to have been of any effect towards the participants (who were probably unaware of this).

The facilities and arrangements for food and beverages have been experienced as close to perfect, as well as the meeting location.

General remarks

For both participants and trainers taking part in and conducting training is not their full-time profession. Predictably it is therefore difficult to keep one's concentration up for 100% of the time, especially when sessions are occasionally relatively long.

We therefore feel the quality of knowledge transfer would benefit from shortening sessions, interrupted by more, shorter breaks. Moreover, this would have given participants more chances for informal reactions, thus potentially solving the challenge of reserve towards public response.

Despite efforts from both the organisation and trainers' side, there was a degree of mismatch between the expected entry level in experience/education of participants and the observed one. We therefore suggest to include on future courses either a better intake procedure of participants, or a more descriptive "who should attend" section at registration/announcement.

Closure

For both trainers it was pleasant that the colleague trainer was a fellow country man he already had a good relationship with.

Both trainers have thoroughly enjoyed doing their respective tasks and enjoyed the social events organised around the training. Given their regular responsibilities, they are both willing and able to contribute to future training programmes, provided it does not put too much strain on their time.



Asia-Pacific
Economic Cooperation



Asia-Pacific
Legal Metrology Forum

APEC/APLMF Seminars and Training Courses in Legal Metrology
(CTI 46 09T)

**Strengthening Legal Metrology Infrastructure for
Trade Facilitation: Mass Flow Meter**

July 6 – 9, 2010
in Singapore

Program

Organizers:

1. Asia-Pacific Economic Cooperation (APEC)
2. Asia-Pacific Legal Metrology Forum (APLMF)

Supporting Organizations:

SPRING, Singapore

Trainers:

- Mr. Wim Volmer, NMi Certin BV, The Netherlands
- Mr. Aart Pruysen, Emerson Process Management, The Netherlands

Main Objective of the Training Course:

This training course on mass flow meters aims to provide participants with a better understanding of the design principle and operation of the Coriolis mass flow meters and the verification of such flow meters in accordance with OIML Recommendation 117 (Dynamic measuring systems for liquids other than water). This course will enhance the technical capabilities of the participants and develop harmonized verification procedures for the control of mass flow meters, thereby ensuring a common understanding and interpretation of the OIML Recommendation. Experiential learning will also be conducted for the participants who will witness on-site demonstrations of conducting reference tests.

Venue and Accommodation:

Accommodation for the participants will be prepared in the Holiday Inn Atrium, Singapore with

a rate of about 145 US dollars for a single room and about 162 US dollars for a double room. Please complete the hotel reservation form to make the reservation.

Travel Support :

- **APEC travel support**, composed of a roundtrip airfare in a discount economy class and per diem including accommodation, would be prepared for the participants from **Chile, P. R. China, Indonesia, Malaysia, Mexico, Papua New Guinea, Philippines, Peru, Russian Federation and Thailand.**
- **APLMF travel support** would be complementary prepared for the non-APEC and full-APLMF member economies; **Cambodia, DPR Korea and Mongolia.**
- The maximum number of supported participants is limited to **ONE** for each economy. The final eligible participants will be decided after an approval by the APEC/APLMF secretariat. All supported participants are required to prepare a presentation with a document during the course. The English proficiency of your selected participant will very much affect the training accomplishments, so we hope you can recommend the right participant for the right training course.
- The candidates of the **APEC support** will be requested to submit an airfare quotation and itinerary in advance and have to wait to buy air ticket until it is approved by the APEC secretariat. Basically, all payment will be reimbursed directly from APEC after the **travel is finished.** The supported participants have to pay their airfare and accommodation temporarily by themselves until the reimbursement.

Presentation from each economy :

- At least **one trainee** from each economy will be requested to provide a **brief presentation** about the legal metrology system on mass flow meters in his/her economy. The **recommended topic-Mass Flow Meters in each economy.** Some guides on presentation are given below.

1 Self introduction

1.1 Explain about your organization and department.

1.2 Explain your professional experience in your organization.

2 Mass Flow Meters used in your economy.

3 Legal metrology system for mass flow meters in your economy.

4 Explain current situation in your economy about the compliance to the international standards/recommendations for mass flow meters.

5 Are there any other requirements from your economy? Do you have any problems in order to implement the legal metrology system (budget, human resources, etc.)?

Registration :

Please complete the attached “**Registration Form**” and send it to the APLMF Secretariat by **1 June 2010.**

Access Information :

It may take about 25 min to arrive at the hotel from the airport. The taxi fare for the taxi ride to the hotel should be SGD 25 to less than SGD 40 (depending on timing of arrival). All taxi fares are charged by taxi-meter.

Currency and Credit Cards :

The local currency is Singapore Dollars. Other than the Singapore dollar, the United States and Australian dollars, Japanese yen, Euro and British pound are also accepted in major shopping centres and department stores.

Major credit cards are widely accepted in Singapore. Hotels, retailers, restaurants, travel agents and even taxi companies readily accept international credit cards.

Climate and Clothing :

Singapore has a warm and humid climate throughout the year with a daily average temperature range of 24°C to 32°C. Rain falls throughout the year, with more consistent rain coming during the monsoon season from November to January. Showers are usually sudden and heavy, but also brief and refreshing.

Electricity Supply :

Singapore’s voltage is 220 ~ 240 volts AC, 50 cycles per second. Most hotels can provide visitors with a transformer, which can convert the voltage to 110 ~ 120 volts AC, 60 cycles per second. The power plugs used in Singapore are of the 3-pin, square-shaped type.



Local Time :

GMT + 8

Contact Persons about the Seminar :

- **APLMF Secretariat** (registration and travel support)

Dr. ZHANG Chao & Mr. GUO Su

APLMF Secretariat

AQSIQ No. 9, Madiandonglu, Haidian District, Beijing 100088, P. R. China

Tel: +86-10-8226-0335

Fax: +86-10-8226-0131

E-mail: sec@aplmf.org aplmf@aqsiq.gov.cn

- **Host in Singapore** (visa assistance, accommodation, venue and access information)

Mr. Adrian Ang

Inspector, Weights and Measures Office, SPRING Singapore

No. 2 Bukit Merah Central Singapore 159835

Tel: +65-6279-1885 Fax: +65-6458-1441

E-mail: adrian_ang@spring.gov.sg

Program

Day 1 July 6, Tuesday	08:30-09:00	<i>Registration</i>
	09:00-09:20	Welcoming address from the host economy Opening ceremony (APLMF Secretariat) Group photo taking
	09:20-09:35	Introduction
	09:35-10:35	Presentation by each economy
	10:35-11:00	<i>Coffee break</i>
	11:00-12:00	Presentation by each economy
	12:00-13:15	<i>Lunch break</i>
	13:15-15:15	Technical Explanation on Coriolis meters
	15:20-15:50	<i>Coffee break</i>
	15:50-17:00	Technical Explanation on Coriolis meters
	18:30-21:00	<i>Welcome Dinner hosted by SPRING</i>
Day 2 July 7, Wednesday	08:30-10:20	OIML R117-1: General
	10:20-10:40	<i>Coffee break</i>
	10:40-12:00	OIML R117-1: Coriolis meters
	12:00-13:15	<i>Lunch break</i>
	13:15-15:20	OIML R117-1: Conversion Devices
	15:20-15:40	<i>Coffee break</i>
	15:40-17:10	OIML R117-1: Associated Measuring Devices
Day 3 July 8, Thursday	08:30-10:30	OIML R117-1: Type Approval Tests
	10:30-10:50	<i>Coffee break</i>
	10:50-12:00	OIML R117-1: Verification Tests
	12:00-13:15	<i>Lunch break</i>
	13:15-15:20	Practical & group exercise
	15:20-15:35	<i>Coffee break</i>
	15:35-17:00	Practical & group exercise
	18:30-21:00	<i>Farewell Dinner hosted by APLMF Secretariat</i>
Day 4 July 9, Friday	08:30-11:00	Technical Visit (Tentative)
	12:00-13:30	<i>Lunch</i>
	13:30-15:20	Overview of training
	15:20-15:35	<i>Coffee break</i>
	15:35-17:30	Closing ceremony

Participants List
APEC/APLMF Seminar and Training Courses in
Legal Metrology (CTI 46/2009T)
Strengthening Legal Metrology Infrastructure for Trade
Facilitation : Mass Flow Meter

No.	Category	Economy	Name	Organization
1	APLMF	P. R. China	Dr. ZHANG Chao	APLMF Secretary, Department of Metrology, AQSIQ
2	APLMF	P. R. China	Mr. GUO Su	APLMF Secretary, Department of Metrology, AQSIQ
3	APEC	Singapore	Mr. Toni Widhiastono	Asia-Pacific Economic Cooperation
4	APEC	Singapore	Ms. Joyce Yong	Asia-Pacific Economic Cooperation
5	Trainer	The Netherlands	Mr. Willem Frederik Volmer	Measurement and Product Safety ServiceNMI Certin BV
6	Trainer	The Netherlands	Mr. Aart Pruijsen	Emerson Process Management
7	Participant	Indonesia	Mr. Henry Gunawan	Directorate of Metrology
8	Participant	Malaysia	Mr. Mohd Noor Mohd Ghafar	National Metrology Laboratory-SIRIM Berhad
9	Participant	Philippines	Ms. MARILYN Fos	National Metrology Laboratory-Industrial Technology Development Institute
10	Participant	Thailand	Ms. Khemsai Rahannok	EASTERN VERIFICATION CENTER (CHONBURI)
11	Participant	Peru	Mr. Nikko Meza Valencia	National Institute for the Defense of Competition and the Protection of Intellectual Property (INDECOPI)
12	Participant	P. R. China	Mr. Gong lei	ChongQing Academy of metrology and quality inspection, China
13	Participant	Viet Nam	Mr. Trinh Quang Nam	Viet Nam Metrology Institute

14	Participant	P. R. China	Mr. Qu Hongqiang	Hebei Provincial Institute of Metrology Supervision and Measurement
15	Participant	P. R. China	Ms. Wan Lifen	Hubei Institute of Measurement Testing Technology
16	Participant	Indonesia	Mr. Amir Syamsa	Directorate of Metrology
17	Participant	Indonesia	Mr. Arif Nurjaya	Legal Metrology Standardisation Center
18	Participant	Indonesia	Mr. Dhani Kartika	Directorate of Metrology
19	Participant	Indonesia	Mr. Hadi Bary Rahmatullah	Metrology Training Center
20	Participant	Indonesia	Mr. Irwan Setiawan	Metrology Training Center
21	Participant	Indonesia	Mr. Hari Santosa	Directorate of Metrology
22	Participant	Indonesia	Mr. H. Mawardi	Regional Verification Office of Jakarta
23	Participant	Indonesia	Mr. Subagyo	Regional Verification Office of Jakarta
24	Participant	New Zealand	Mr. Julian Crane	Measurement and Product Safety Service
25	Participant	Viet Nam	Mr. Nguyen Hoang Nam	Viet Nam Metrology Institute
26	Local Participant	Malaysia	Ms. Ong Gek Lin	Mogas Sdn Bhd
27	Local Participant	Singapore	Mr. Francis Tan	SGS Testing & Control Services (S) Pte Ltd.
28	Local Participant	Singapore	Mr. Daniel Ho	SGS Testing & Control Services (S) Pte Ltd.
29	Local Participant	Singapore	Ms. Angela Lum Hung Yin	Shell Eastern Trading Limited
30	Local Participant	Singapore	Mr. Peter Ching	Shell Eastern Petroleum (Pte) Ltd.
31	Local Participant	Singapore	Mr. Desmond Chong	Sinanju Marine Services Pte Ltd.

32	Local Participant	Singapore	Mr. Kenneth Kee	Society of Naval Architects & Marine Engineers Singapore
33	Local Participant	Singapore	Ms. Jesline Lim	SPRING Singapore
34	Local Participant	Singapore	Mr. Teoh Seng Eng	Mogas Flow Lab Pte Ltd.
35	Local Participant	Singapore	Mr. Tay Kok Leong	Sentek Marine and Trading Pte Ltd.
36	Local Participant	Singapore	Mr. Wu Jian	Agency for Science, Technology & Research
37	Local Participant	Singapore	Mr. Dennis Sim	SGS Testing & Control Services (S) Pte Ltd.
38	Local Participant	Singapore	Mr. Ace Leong	Maritime and Port Authority of Singapore
39	Local Participant	Singapore	Mr. Gerald Loh	Maritime and Port Authority of Singapore
40	Local Participant	Singapore	Mr. Dandee Bacani	Endress + Hauser (S. E. A.) Pte Ltd.
41	Local Participant	Singapore	Mr. Lim Kay Wee	Emerson Process Management
42	Local Participant	Singapore	Mr. Thiang Cheong Sheng	Ocean Tankers Pte Ltd.
43	Local Participant	Singapore	Mr. Simon Neo	Equatorial Marine Fuel Management Pte Ltd.
44	Local Participant	Singapore	Mr. Seah Khen Hee	Convenor, TC for Bunkering
45	Local Participant	Singapore	Mr. Kolin Low	Singapore Accreditation Council
46	Local Participant	Singapore	Mr. Jason Tan	Singapore Accreditation Council

47	Local Participant	Singapore	Ms. Lena Soh	SPRING Singapore
48	Local Participant	Singapore	Ms. Jessie Koh	SPRING Singapore
49	Local Participant	Singapore	Mr. Phang Long Hwa	SPRING Singapore
50	Local Participant	Singapore	Mr. Lim Yong Seng	SPRING Singapore
51	Local Participant	Singapore	Mr. Adrian Ang	SPRING Singapore
52	Local Participant	Singapore	Mr. Kriegsman Tan	SPRING Singapore
53	Local Participant	Singapore	Mr. Daniel Ng	SPRING Singapore
54	Local Participant	Singapore	Mr. Long Jun-ming	SPRING Singapore
55	Host	Singapore	Mr. Tan Kai Hoe	SPRING Singapore
56	Host	Singapore	Mr. Teo Nam Kuan	SPRING Singapore
57	Host	Singapore	Mr. Steven Tan	SPRING Singapore
58	Host	Singapore	Mr. Michael Ong	SPRING Singapore
59	Host	Singapore	Ms. Amanda Foo	SPRING Singapore
60	Host	Singapore	Mr. Ooi Cheong	SPRING Singapore

Who am I?

- Wim Volmer
- B.Sc. Applied Physics
- At NMI since 1995
- First, Type Approval Engineer
- Now, Product Manager Oil & Gas
 - Harmonisation (legal)
 - Non-standard projects
 - Project Manager Metrology EuroLoop
- Welmec WG-10 Conveyor (Liquids other than Water)

Coriolis

Direct Mass Metering

Wim Volmer, NMI Certin BV

Contents 7 July

- OIML R117-1 General
- R117-1 Coriolis
- R117-1:
 - Conversion device
 - Correction device
 - Associated measuring device
- Please, DO interrupt for questions

This week's goal ...

- Is that you learn about Coriolis meters



ions

Skipped, unless ...

- Indicating Device
- Totaliser
- Calculator
- Memory Device
- Zero-setting Device
- Adjustment Device



Symbols

M	Mass
V	Volume
Q	Flow
T	Temperature
p	Pressure
t	Time
f	Frequency
ρ	Density
η	Viscosity
Δ	Delta / difference

OIML R117-1 General



What is OIML?

- Legal Metrology Organisation
- Issues Recommendations
- Aims world-wide
- If members implement Recommendation:
 - Technical requirements are harmonised
 - Barriers to Trade are lowered
 - Opens the path to: test once, Approve world-wide

Typical Recommendation

- Part -1: technical requirements
- Part -2: test procedures
- Part -3: report format
- If all 3 published, OIML Certificate of Conformity (CoC) possible



What is R117-1?

- Dynamic Measuring Systems for Liquids other than Water
- So no static measurement (nor discontinuous measurement)
- Exclusion: Cryogenic R81
- A HUGE SCOPE!!!
- PS: R117-2 Draft expected 2010

Did you know?

- All Recommendations downloadable from www.oiml.org for free!!



- And lots more



Why use R117-1?

- Known world-wide
- Not in conflict with European MID (Measuring Instruments Directive)
- Acceptance by “Gentlemen’s agreement”
- Works quite well
 - OIML tests generally accepted
 - National differences still exist
- To be included in MAA (Mutual Acceptance Arrangement)

R117-1 document structure



4/2/2019

10:05 AM

R117-1 document structure#1

- Terminology!!!
 - Not in-line with process terminology
 - Great help for electronic "FIND"
 - E.g. measurement device / sensor [T.a.7 & Ta.8]
 - "Device" used for "Function", although not separable [T.c.5]
- Chapter 1: Field of application (scope)
 - Excludes Water meters R49 and Heat meters R75
 - Please know cryogenics are also excluded (for now)



4/2/2019

10:05 AM

R117-1 document structure#2

- Chapter 2: General Requirements
 - Always apply + specific requirements further in document
- It answers the basic questions:
 - What is the smallest measuring system?
 - Are two parallel meters 1 or 2 meters?
 - Is a Gas Elimination Device always needed?
- AND, what are the Maximum Permissible Errors (later in training)



4/2/2019

10:05 AM

R117-1 document structure#3

- Chapter 3: Meters and ancillary devices
- Rated operating conditions [3.1.1.1]
 - Flow / Reynolds
 - Viscosity
 - Density
 - Temperature (ambient & liquid)
 - Pressure
- Correction Device [3.1.4]
- "General meter requirements" [3.1.5.1 to 3.1.5.4]
- Coriolis [3.1.9]



4/2/2019

10:05 AM

R117-1 document structure#4

- Chapter 4: Electronic devices
- Interruptible vs. non-interruptible
- Note: some are device requirements, others system requirements!!!
- Checking facilities
 - Potential problems → Alarm
 - Alarms just as important as measured quantity
 - Impossible to measure = not a significant fault [T.f.1]



Non-interruptible



8-1-2019 10:08:50 AM

8-1-2019 10:08:50 AM

R117-1 document structure#5

- Chapter 5: Applications
- Pipeline & Ship loading [5.7]
 - Additional requirements on top of General [Chapter 2] and Specific Requirements [Chapters 3 & 4]
- ...



R117-1 document structure#6

- Chapter 6: Metrological Control
- Modular character [6.1.1]
- [6.1.10] System Approval based on existing "part Approvals"
- [6.2.1] Initial Verification in one or two stages
 - Laboratory tests / calibration on meter +
 - Field evaluation complete system

8-1-2019 10:08:50 AM

8-1-2019 10:08:50 AM

R117-1 document structure#7

- Annex A: Type Approval Tests
- [A.1] Change 1 influence factor at a time
- [A.5, A.6 & A.7] "wet tests"
- [A.9] Conversion device
- Annex B: Hints and Tips
- [B.A.6.2] Operating range!!



4-12/2016

4-12/2016

R117-1 Document Summary

- Terminology: what's in a name
- Covers more than the meter
- Applicable requirements determined by:
 - General Requirements
 - Technology / measurement principle
 - Application
- Modular character → compatibility



4-12/2016

4-12/2016

Modular character R117-1



4-12/2016

4-12/2016

R117-1

- Measuring **SYSTEMS** for Liquids other than Water
- Often made up of Parts produced by different manufacturers



4-12/2016

4-12/2016

Typical System

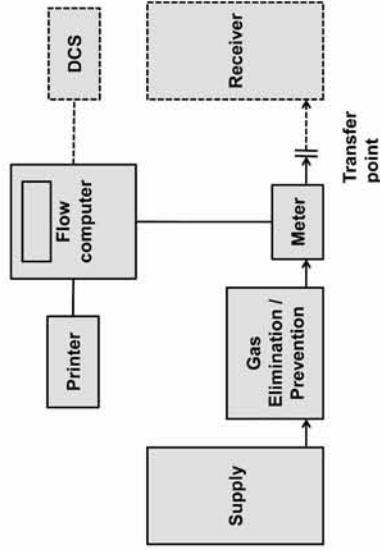

Example

User wishes to have System:

- Flowcomputer make A
- Meter make B
- His own Gas Elimination Device

Modularity

R117-1 [6.1.1]:

- Constituent elements
- Separate "Approval" possible
- System Approval \leftrightarrow Part Approval
- Needed:
 - Part defined as Constituent Element
 - Partial Times to test against
 - Compatibility recorded
 - System Approval for the combination

Approval examples

- | | |
|-------------------|-------------------|
| System | System |
| Approval#1: | Approval#2: |
| • Meter part | • Meter part |
| • Approval A + | • Approval A + |
| • Flowcomputer | • Flowcomputer |
| part Approval D | part Approval C |
| + | + |
| • Gas Elimination | • Gas Elimination |
| part Approval E | part Approval F |

Modularity summary / advantage

- Base System Approval on Part Approval
- Approval Document Structure aligned with practical System structure
- Easy to make different combinations
- Easier to combine parts from different manufacturers
- Easier document maintenance



8-12010

TRUE VALUE

CHECK COMPATIBILITY!



8-12010

TRUE VALUE



Questions?



8-12010

TRUE VALUE

TRUE VALUE

- + Testing + + + + +
- + Certification + + + + +
- + Calibration + + + + +
- + Training + + + + +



R117-1 Coriolis

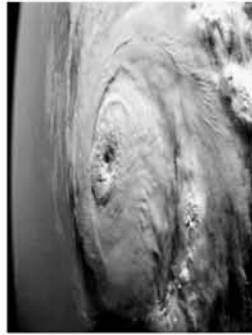

8-12019 47206 100% VALUE

First: Mass vs. weight

- Physics:
 - Mass is constant
 - Weight depends on ...
 - (mass in vacuum, commercial mass, weight in air, ...) air buoyancy, gravitational force

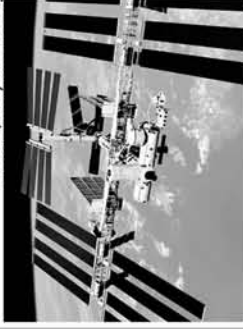

8-12019 47206 100% VALUE

Coriolis [3.1.1]

- [3.1.1] Rated operating conditions
- **Meter vs. Measuring Device [3.1.2 + 3.1.2.1]**
- [3.1.2.2] Repeatability = 2/5 of Line A
- Later:
 - [3.1.4] Correction Device



8-12019 47206 100% VALUE

Coriolis [3.1.5.1 ... 3.1.5.3]

- [3.1.5.1] Avoid cavitation:
 - Short-term: vapour
 - Long-term: mechanical damage
- [3.1.5.2 + 3.1.5.3]: flow disturbances
 - I never saw an effect
 - Problems possible due to cavitation (half-open valve) or vibration (pumps, control valves, ...)



8-12019 47206 100% VALUE

Low-flow cut-off [3.1.5.4]

- Low-flow cut-off:
 - Suppress small flows (convection)
 - Higher flows → everything is counted, incl. cut-off value

Low-flow cut-off (2 kg/min)

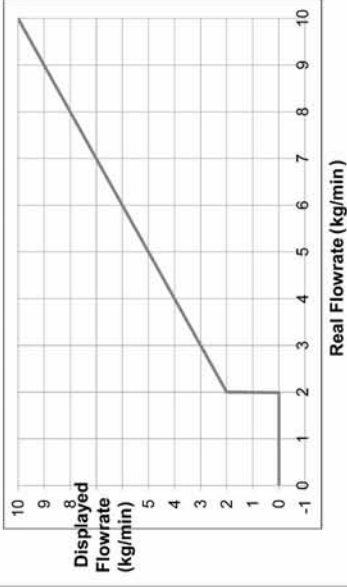

Low-flow cut-off vs. Zero

Coriolis:

- Low-flow cut-off > Zero stability
- Zero stability $\leq 1/5 Q_{\min}$
- Low-flow cut-off > Zero stability $\leq 1/5 Q_{\min}$
- In other words, poor Zero stability increases Q_{\min}

Zero

- Zero:
 - Setting (stored value)
 - Stability (usually very small, unpredictable)
 - Monitoring (check, without changes)
- Causes:
 - Mechanical imperfections
 - Installation stresses
- Effect decreases proportional with flowrate
 - Error = Offset + Zero / Flowrate
 - E = 0.05% + 3 (kg/min) / Flowrate (kg/min)

Zero

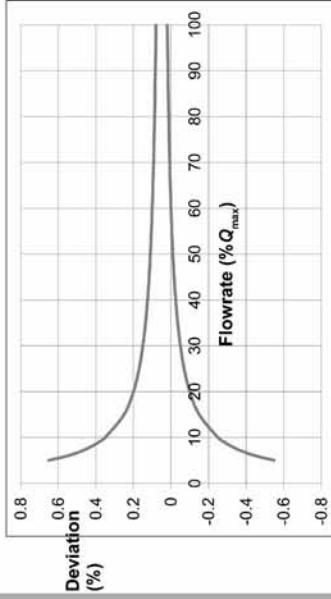

Zero / correction

- If Zero setting and stability perfect:
- Horizontal error curve at offset
- Zero stability is unpredictable so,
- Effect could be positive one day and negative the other
- Correction through linearisation can double the effect!!

Correction Device [3.1.4]



- Integral part of meter
- Commonly known correction: linearisation (flow-dependent correction)
- Coriolis correction devices:
 - Temperature
 - Pressure
 - Zero?
 - ...
- A perfect correction device is “invisible”

Temperature correction#1

- Tube temperature affects vibration properties
- Resonant frequency (density) changes
- Time difference (mass) changes
- Simple equation suffices for “small” temperature window
- At extreme temperatures more complex equation needed

Temperature correction#2

Ambient, tube and liquid temperature

Ambient

Secondary Containment

What if Ambient temperature >>> Liquid temperature?

Pt-100

Tube Wall

Liquid

Tube Wall

Secondary Containment



Coriolis [3.1.9]

- Manufacturer's installation specifications, e.g.:

— Stress-free installation \leftrightarrow Zero

— "Free of external vibrations" \leftrightarrow Tube vibration

- Possibly more specifications in Approval, e.g.:

— Up- and downstream block valves \rightarrow No flow during Zero

— Orientation for gas / air / vapour

— ...

4-2008

100% VALUE



Temperature correction#2

Ambient, tube and liquid temperature

Ambient

Secondary Containment

What if Ambient temperature >>> Liquid temperature?

Pt-100

Tube Wall

Liquid

Tube Wall

Secondary Containment

4-2008

100% VALUE



R117-1 Coriolis Summary

- General section [3.1.1 ... 3.1.5.4] (despite [3.1.5] heading "Turbine meters")
- Includes Correction device
- Specific section [3.1.9]
- All in all not that many articles



Questions?



4-2008

100% VALUE

4-2008

100% VALUE

TRUE VALUE

- + Testing
- + Certification
- + Calibration
- + Training

R117-1 Conversion Devices Correction Devices Associated Measuring Devices



Coriolis Data Processes

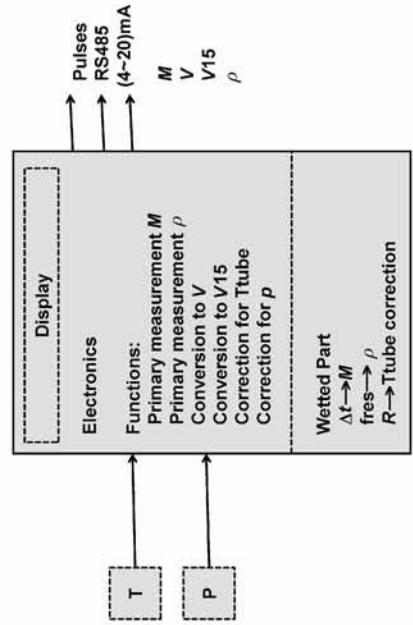

Now, in practice ...

Lots of versions available:

- "Blind" models (no display)
- No external T and/or p
- Fewer outputs
- No $V15$

All known types:

- Measure M and ρ
- Calculate / convert to V
- Correct for Ttube

So, “Coriolis meters” can be:

- Meter
- Measuring Device
- Indicating Device
- Totalizer
- Calculator
- Conversion Device
- Correction Device
- Associated measuring device / sensor / transducer
- Memory Device
- Zero-setting Device
- Adjustment Device



Conversion

- [T.c.4]
- Primary measurements: Mass and Density at metering conditions
- Volume at metering conditions
- Volume at base conditions
 - Liquid temperature needed
 - Iterative calculation needed



Correction

- [T.c.5]
- Automatic
- Coriolis temperature correction: based on characteristics of Tube (not liquid)
- Note: similar to ultrasonic meters



Temperature

- Liquid vs. Ambient temperature
- Tube temperature for correction
- Liquid temperature for conversion to V15

Internal T for conversion:

- Either prove $T_{\text{tube}} = T_{\text{liquid}}$, or
- Apply separate T-probe



Density

Density can be measured for:

- Conversion to Volume
- Conversion to Volume15
- Correction for density effect (on mass measurement)
- Transmission to flowcomputer (densitometer function) by:
 - Analogue signal
 - Digital signal



Effects

- Temperature increase → tube stiffness decrease
- Pressure increase → tube stiffness increase
- Density, unpredictable
- Viscosity, only in very extreme cases
- Reynolds, only in very extreme cases

Lots of devices, summary

- Requirement depends on which device it is
- Some signals / quantities can have multiple functions
- Determine what part of the process you are looking at
- Note: correction device usually has no separate MPE

Questions?





MPE's/ Legal Limits



4-2020

TRUE VALUE

TRUE VALUE

- + Testing
- + Certification
- + Calibration
- + Training



Coriolis Mass

- Mass is the primary quantity
- Based on time difference, analogue
- Converted into digital value
- Digital value is processed
- Processed value "sent" to the outside world, via:
 - Display
 - Analogue output
 - Digital output
- All the same MPE from Line B

4-2020

TRUE VALUE



Coriolis Schematic #1 Mass

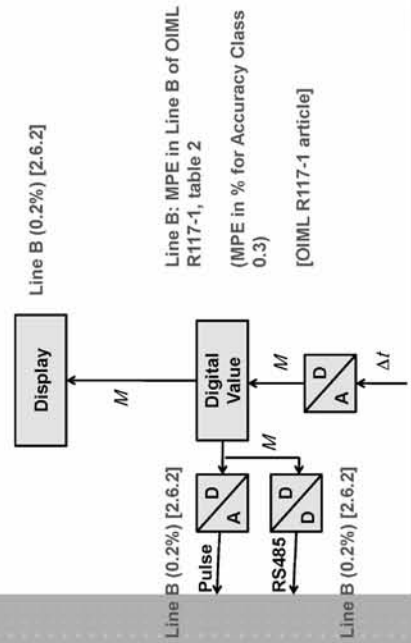

4-2020

TRUE VALUE

“Normal” Conversion

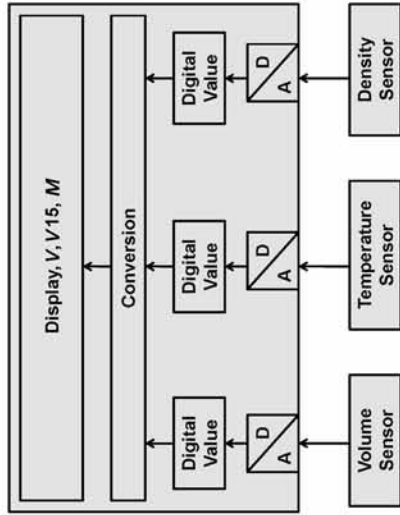

Coriolis Schematic #2 Volume

V: Line A = B + C (0.3%) [2.7.1.2]

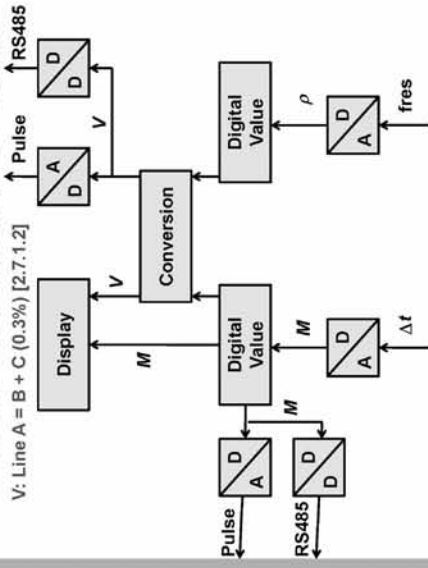

Coriolis Volume

- Volume is calculated from Mass and Actual Density → Volume at metering conditions
- $MPE(\text{conversion}) = \text{Line C}$
- This is on top of $MPE(\text{mass})$ Line B
- → $MPE(\text{volume}) = \text{Line A}$

Coriolis Schematic #3 Density

$MPE (\pm 1 \text{ or } 5 \text{ kg/m}^3)$ [2.7.2.2.3, table 4.2]

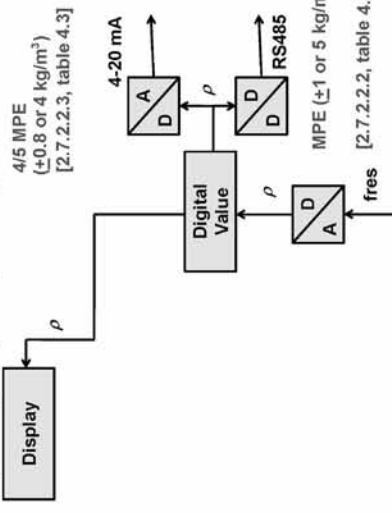

4/5 MPE
(±0.8 or 4 kg/m³)
[2.7.2.2.3, table 4.3]

$MPE (\pm 1 \text{ or } 5 \text{ kg/m}^3)$
[2.7.2.2.2, table 4.2]

Coriolis Density#1

- Density is the other primary quantity
- Based on resonant frequency, analogue
- Converted into digital value
- Digital value is processed
- Processed value "sent" to the outside world, via:
 - Display
 - Analogue output
 - Digital output

Coriolis Density#2

- Possible application: as Densitometer only (mass measurement not used)
 - Density output used as input for other system
 - Associated Measurement Sensor
 - signal conversion in flowcomputer
 - Together Associated Measurement Device

Coriolis Schematic #4 Typical

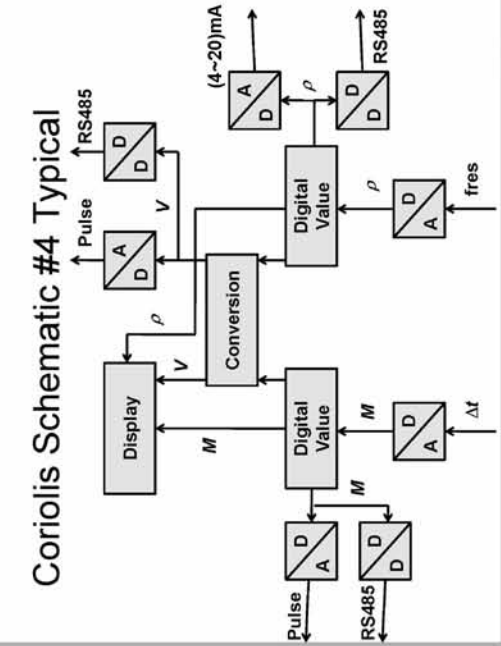

Coriolis: R117-1 devices

- Meter
- Measurement transducer
- Conversion device(s)
- Associated measurement sensor
- Associated measurement device
- Note#1: it also includes correction device(s)
- Note#2: R117-1 device = function

Special: Coriolis Volume(15)

V15: Line A = B + C (0.3%) [2.7.1.2]

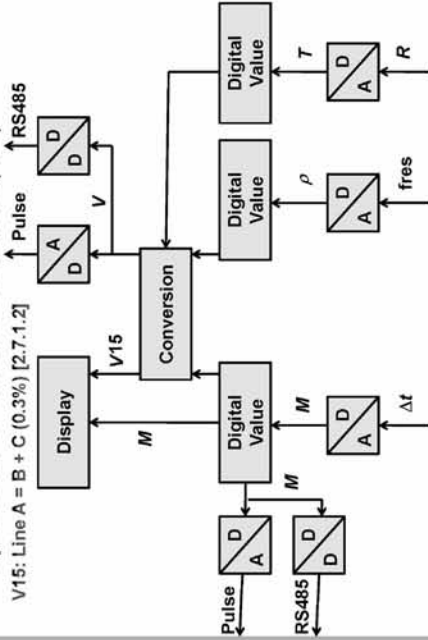

Coriolis Volume(15)

- Base Volume is calculated from Mass and Base Density → Volume at base conditions
- MPE(conversion) = Line C
- This is on top of MPE(mass) Line B
- MPE(volume) = Line A
- Requires additional temperature measurement!

MPE's summary

- Study the schematics
- MPE depends on signal type, analogue or digital
- MPE depends on purpose (density for internal / external use)
- This is probably the most difficult section

Questions?

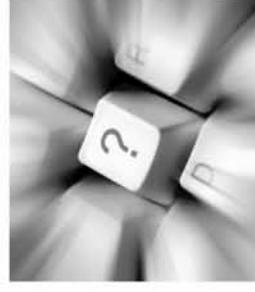

Welcome back



TRUE VALUE

- + Testing
- + Certification
- + Calibration
- + Training

Contents 8 July

- Type Approval Tests
 - "Wet" tests
 - EMC / Climate [Annex A]
 - Software
- Initial Verification Tests
 - Meters vs. Systems
- Enforcement / Market Surveillance Tests
- Measurement Uncertainty

Legal regime

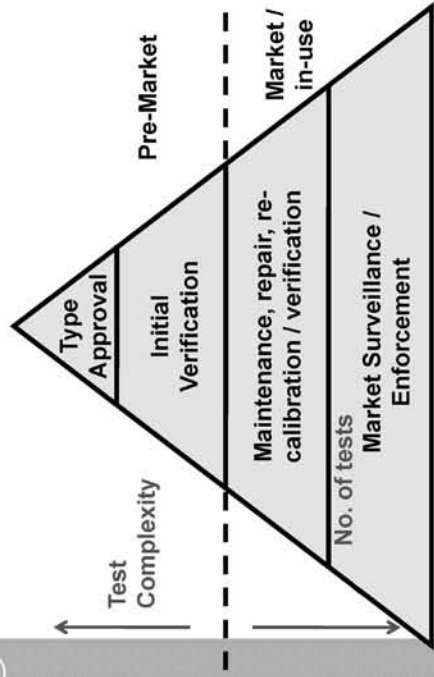

Type Approval



11/2015

TYPE APPROVAL

Type Approval Overview

Goal:

- Get to know the type of meter / system
- Quantify effects (flow, ambient & liquid temperature, pressure, ...); in other words, determine operating range
- Determine sensitivities to EMC
- Functional design (checking facilities, software, indications, ...)



11/2015

TYPE APPROVAL

Test Philosophy

- Test 1 influence / effect at a time (simultaneous influences ignored)
- Generally, assume high quality process and installation (clean products, straight lengths, etc.)
- Alarms to indicate possible problems (knowing when wrong, not necessarily always right)
- User protection, not consumer protection
- Metrology = 95% confidence



11/2015

TYPE APPROVAL

Type Approval Wet tests

- Cover the flow range
- Minimum measured quantity
- Flow interruption
- Process parameter ranges (temperature, pressure, ...)
- [Annex B]



11/2015

TYPE APPROVAL

Type Approval Climate Ambient

- Annex A tests intended for electronics
- Temperature has potential effect on both electronics and mechanics
- How test electronics, without mechanics?
 - Electronics in climate chamber, sensor **not**
 - Pickoff coils are not considered as electronics



Conversion Device [2.7]

First Approach:

- Conversion Device complete:
 - Associated measuring device
 - A/D convertor
 - Conversion calculation
 - “Display” converted quantity

Second Approach:

- Separate testing associated measuring sensor / device ...



Functionality / software



- Indication: 00001234.56789 kg
- Checking Facilities / data security
- Power out—> save data



Initial Verification



Initial Verification overview

- Conformity to type:
if OK, assume compliance with EMC,
climate etc.
- Test / Evaluation:
“wet tests” + ...
- Judgment:
YES → Marking & Sealing



Initial Verification

- R117-2 not published → no detailed
test procedures
- R117-1 [6.2]: one or more stages
 - Laboratory calibration of meter
 - Note: Field calibration often difficult
 - Laboratory calibration T and P
 - Field checks
- Tests on other system components

Meters vs. Systems

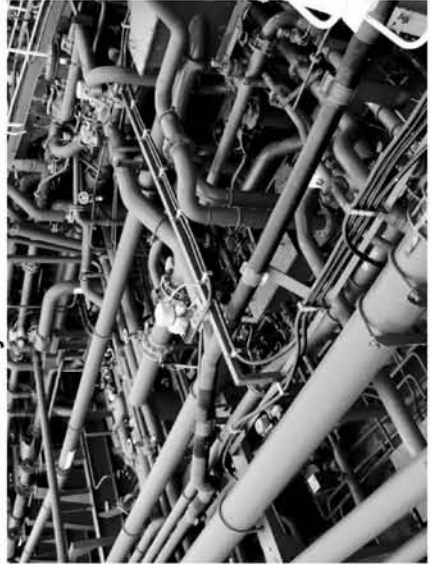

System Approval / Verification

Assume we have a good meter ...

What could possibly go wrong?

- Gas Elimination / Prevention of gas
- Compatibility
- Unclear Transfer Point
- Power Supply / UPS / (non)-
interruptible
- Empty hose, or full hose, or ...
- ...

Empty / full hose, or ... Barges

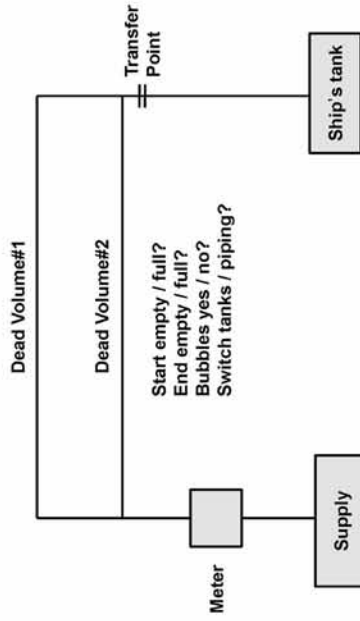

Summarised ...

It takes more than a good meter to make a good measurement



Enforcement / Market Surveillance / Inspection / Re-Verification



Enforcement

Two basic types:

- Fixed re-verification period
 - Combination of 2 bottom layers pyramid
- Random inspection
 - Continuous threat
- Challenge: what is re-calibration period?
- Alternative?

Re-calibration period

- Application defined
- Affected by changes in:
 - Installation (Zero)
 - Process parameters (T , ρ , etc.)
 - Wear and tear (solids in liquid)
 - Corrosion
 - Fouling / waxing
 - ...
- However, if tubes unaffected ... ?



Gain confidence in meter

- Perform "wet" tests, or
- Diagnostics:
 - Zero check
 - Density check (what is "true" density?)
 - Effect on density \gg effect on mass, so if density OK, mass OK
- + user data?

Testing, summary

- Coriolismeters are not plug-and-play devices; it takes knowledge to test them
- There are alternatives to:
 - Field tests
 - Full testing during inspection
- Poor installation kills a good meter



Questions?



Operating Range / Compatibility



TRUE VALUE

- + Testing
- + Certification
- + Calibration
- + Training

Example#1

- “This Coriolis meter is Approved for - 200 ... +200 °C; within this range a maximum 60 °C window must be applied”
- It works well at low and high temperatures, provided:
 - The temperature change is not too large, or
- The temperature correction works well over a 60 degree range

Example#2

- “This Coriolis meter is Approved for 0 ... 40 bara; over 40 bara pressure correction needs to be applied”
- It works well, without pressure correction up to 40 bara, or
- Below 40 bara the pressure effect is small enough

Overview, graphic

Type Approval

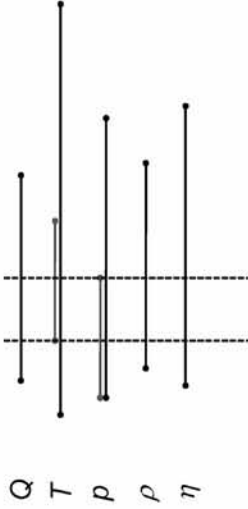

Application
Initial Verification

Example#3, numerical

- T-correction OK: 0.005% / °C
- ρ -effect: 0.01% / bara
- η -effect: 0.007% / cSt
- ...
- Zero + T-correction + ρ -effect + η -effect + ... \leq MPE
- $0.05 + 0.005 \cdot \Delta T + 0.01 \cdot \Delta \rho + 0.007 \cdot \Delta \eta + \dots \leq 0.3$

Summary#1

- Perform tests (close to) limits of operation [Annex B]
- Determine influences at Type Approval
- Record in Type Approval Certificate
- Check Application range
- Fit, or fit with correction?
- Application range on system Data Plate

Summary#2

- Principle can be applied to determine liquid and process conditions at Initial Verification!!
- So laboratory calibration on water at 20 °C and 3.5 bara can represent
- Application on Crude Oil at 45 °C and 8 bara
- See [6.2.1, bottom paragraph]

Questions?



Measurement Uncertainty



TRUE VALUE

- + Testing
- + Certification
- + Calibration
- + Training



OIML R117-1, A.2

Type Approval & Initial Verification:

- $U < 1/5 \text{ MPE}$
- Based on "Shared Risk Principle"
- Alternative in other Recommendations (R137, Gasmeters), not in R117-1

Shared Risk Principle: Type Approval & Initial Verification

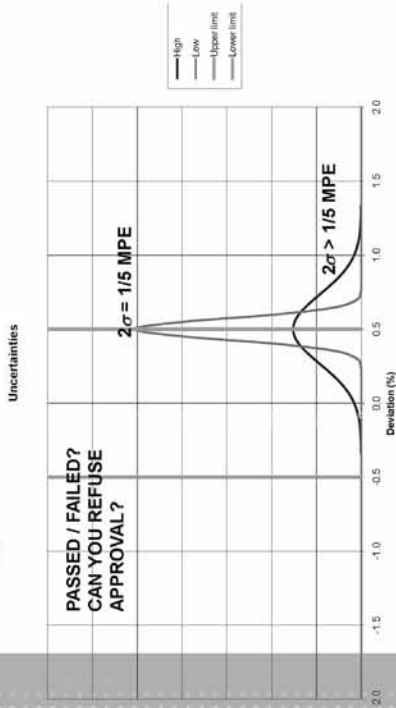

Shared Risk

- Manufacturer and Authority share the risk 50/50
- 95% (97.5%) chance of right decision within +/- 0.6%

Uncertainty: Market Surveillance / Enforcement

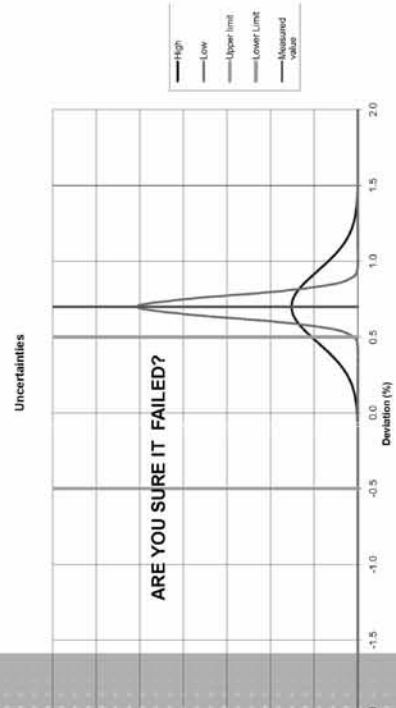

Will it stand up in court?

- Can you really prove it is wrong?
- Owner can be prosecuted
- 99% Confidence = 3σ ?
- Type Approval and Initial Verification - > Shared Risk
- Enforcement →

Uncertainty, summary

- Type Approval and Initial Verification: Shared Risk
- Enforcement: make sure it is off-spec



Questions?



TRUE VALUE

8-2016

The End



TRUE VALUE

8-2016

TRUE VALUE

- + Testing
- + Certification
- + Calibration
- + Training



Welcome on Practical session
APLFM conference
July 8, 2010

by
Wim Volmer and Aart Pruysen



Agenda practical session

- Wim Volmer:
- Recap/summary OIML R117-1
- Aart Pruysen
- Type approval tests example (marine)
- Aart Pruysen ; Practical session
- Global Calibration Traceability of Micro Motion
 - Coriolis equations by Micro Motion
 - All subjects related to zero
 - Explain water calibration/configuration sheet
 - Exercises



Micro Motion Conference
Page 1

Agenda practical session

- Global Calibration Traceability of Micro Motion
- Coriolis equations by Micro Motion
- All subjects related to zero
- Explain water calibration/configuration sheet
- Exercises



Micro Motion Conference
Page 3

Agenda practical session

- Global Calibration Traceability of Micro Motion
- Coriolis equations by Micro Motion
- All subjects related to zero
- Explain water calibration/configuration sheet
- Exercises



Micro Motion Conference
Page 4

Global ISO/IEC 17025 Traceability

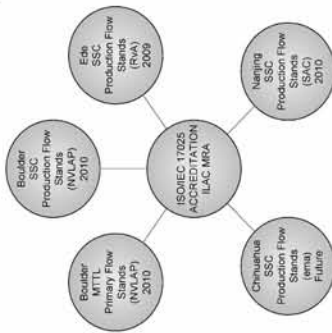

Micro Motion Confidential
Page 1

Micro Motion Global Calibration

- Micro Motion focuses on two primary aspects of calibration quality with its calibration maintenance process
 - Traceability to international standards
 - Consistent calibrations between facilities
- Three methods are used to ensure consistency and traceability of the calibration stands
 - Certified mass standards
 - Global Reference Meters (GRM) with Accredited calibrations
 - Inter-laboratory test program utilizing multiple national laboratories
 - NIM – China
 - NIST – USA
 - VSL – The Netherlands



Micro Motion Confidential
Page 4

Micro Motion Global Traceability

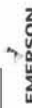
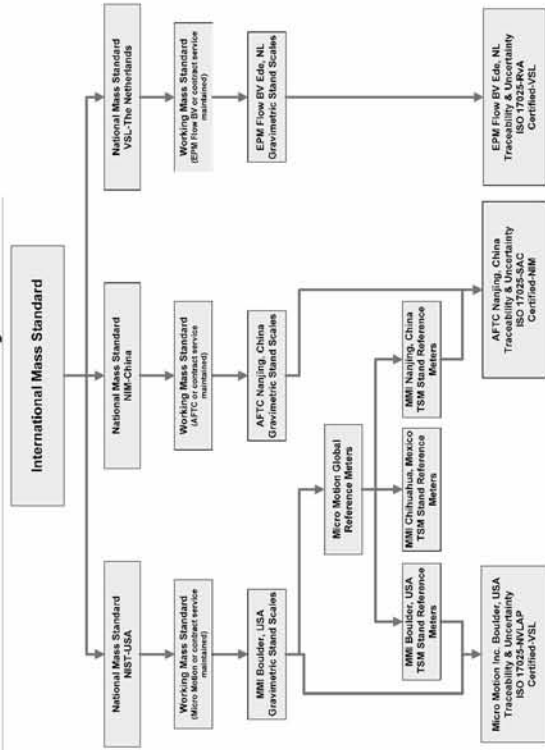

Micro Motion Confidential
Page 7

Micro Motion Today



Micro Motion Confidential
Page 8

Micro Motion's Global Production Calibration Facilities

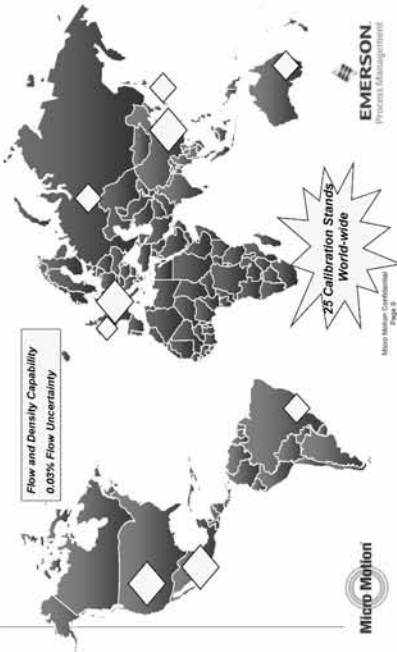

Agenda practical session

- Global Calibration Traceability of Micro Motion
- Coriolis equations by Micro Motion
- All subjects related to zero
- Explain water calibration/configuration sheet
- Exercises



Micro Motion Confidential
Page 12

Mass equation

Equation in software of Micro Motion Coriolis meter :

$$Q_{ind} = MF_m \left(1 - \frac{FT}{10000} \right) \left[1 + FP (P_{oper} - P_{cal}) \right] FCF^s \left(\Delta T_{max} - \Delta T_{(ind)} \right)^{VF}$$

where

- Q_m-indicated (g/s)
- MF_m-Meterfactor for mass (-)
- FCF - Flow Cal Factor, unique for each sensor (g/s/μs)
- FT_{sensor} - temperature coefficient for mass flow, as configured in the Micro Motion electronics (% per 100 °C)
- T_{sensor} - temperature, as measured by micro Motion (°C)
- FP_{sensor} - pressure coefficient for mass flow, as configured (% per psi)
- P_{oper} - pressure, as measured externally and connected to Micro Motion electronics via HART (psi)
- P_{cal} - pressure at which the factors were determined during calibration (psi)
- ΔT_{measured} - Measured time difference as determined by Micro Motion (μs)
- ΔT_{zero-stored} - Stored time difference in Micro Motion electronics for no flow conditions (μs)
- VF - Viscosity Factor (μs)



Micro Motion Confidential
Page 11

Mass equation

What is effect in mass if stiffness of tube material changed with -1%?

What is effect in mass at 50 °C if FT has been changed from 4.00 to 3.00 % per 100°C?

What is effect in mass if temperature measurement of Coriolis meter has shifted since water calibration with 1 °C for FT= 4.00 % per 100 °C

What is effect in mass if pressure correction is not applied for HC3 sensor (-0.015% per bar) for a pressure of 4 bar?



Micro Motion Confidential
Page 13

Density equation

$$\rho_{\text{fluid}} = \frac{\left(\frac{1 - DT}{10000} * T_{\text{cmp}} \right) * T^2 - K_1^2}{K_2^2 - K_1^2} * (D_2 - D_1) + D_1 + Dp * (P_{\text{oper}} - P_{\text{atm}}) - F * D * \Delta T^2$$

Where:

- ρ_{fluid} - density fluid (g/cm³)
- DT - density temperature coefficient (% per 100 °C)
- T - temperature, as measured by coriolis meter (°C)
- T - period time of vibrating tubes for density meter (µs)
- K_1 - period time of vibrating tubes at density D1 (air or 0) (µs)
- K_2 - period time of vibrating tubes at density D2 (water or 1) (µs)
- D_1 - density for which period K1 is valid (g/cm³)
- D_2 - density for which period K2 is valid (g/cm³)
- Dp - density pressure coefficient (g/cm³/psi)
- P_{oper} - operating pressure (psi)
- P_{atm} - calibration pressure (psi)
- $F * D$ - flow effect density (g/cm³/µs²)
- ΔT - measured time difference left and right (µs)



Micro Motion Confidential
Page 11



Density equation

Simplified:

$$\rho = C_1 \cdot \left(1 - \frac{DT}{10000} * T_{\text{cmp}} \right) T^2 - C_2$$

$$C_2 \approx 2.500 \text{ kg/m}^3$$

Relation between K's and C's:

$$C_1 = \frac{D_2 - D_1}{\left(\frac{K_2^2}{K_1^2} - 1 \right)} \quad C_2 = \frac{K_1^2 * (D_2 - D_1)}{\left(\frac{K_2^2}{K_1^2} - 1 \right)} - D_1$$



Micro Motion Confidential
Page 11



Density equation

What is effect in density if stiffness changed with +1%?

What is effect in density at 50°C if DT has been changed from 4.00 to 3.00 % per 100°C?

What is effect in density if temperature measurement of Coriolis meter has shifted since water calibration with 1 °C for DT= 4.00 % per 100 °C

What is effect in density if pressure correction is not applied for HC3 sensor (-0.037 kg/m³ per bar) for a pressure of 4 bar?



Micro Motion Confidential
Page 11



Agenda practical session

- Global Calibration Traceability of Micro Motion
- Coriolis equations by Micro Motion
- All subjects related to zero
- Explain water calibration/configuration sheet
- Exercises



Micro Motion Confidential
Page 11



Coriolis meter

Zero setting and Zero verification



Agenda

- Zero phenomena
- Zero setting
- Zero verification



Micro Motion Confidential
Page 13



Zero phenomena

The Coriolis meter may already measure a time difference when there is no flow due to manufacturing tolerances. Therefore software will correct for this offset.

After installation and during commissioning, this offset will have to be stored in the electronics during NO FLOW condition and is called $\Delta T_{\text{zero-stored}}$. This is called "ZERO SETTING".

Simplified mass equation:

$$Q_m = FCF * \Delta T_{\text{measured}} - Q_{\text{zero-stored}}$$

OR (e.g. Micro Motion)

$$Q_m = FCF * (\Delta T_{\text{measured}} - \Delta T_{\text{zero-stored}})$$



Micro Motion Confidential
Page 13



Zero phenomena

The measured time difference during operation is sum of time difference due to mass flow and time difference for no flow conditions $\rightarrow \Delta T_{\text{meas}} = \Delta T_{\text{massflow}} + \Delta T_{\text{zero-actual}}$

Zero setting means that the measured time difference at that moment during no flow is stored as $\Delta T_{\text{zero-stored}}$.

$$\Delta T_{\text{meas}} = \Delta T_{\text{zero-actual}} \rightarrow \text{new } \Delta T_{\text{zero-stored}}$$



Micro Motion Confidential
Page 13



Zero phenomena

Mass flow calculation corresponds therefore with:

$$Q_m = FCF * (\Delta T_{\text{massflow}} + \Delta T_{\text{zero-actual}} - \Delta T_{\text{zero-stored}})$$

If $\Delta T_{\text{zero-actual}}$ remains stable over time ($\Delta T_{\text{zero-actual}} = \Delta T_{\text{zero-stored}}$), the mass flow is calculated based only on $\Delta T_{\text{massflow}}$, which is correct.

If $\Delta T_{\text{zero-actual}}$ shifts over time ($\Delta T_{\text{zero-actual}} \neq \Delta T_{\text{zero-stored}}$), the mass flow is calculated with an absolute bias:

$$\Delta Q_{m-\text{zero}} = FCF * (\Delta T_{\text{zero-actual}} - \Delta T_{\text{zero-stored}})$$



Micro Motion Confidential
Page 21



Zero phenomena

The relative% error due to zero depends on actual operating flowrate and is biggest at lowest flowrate:

$$\frac{\Delta Q_{m-\text{zero}}}{Q_m} = \frac{FCF * (\Delta T_{\text{zero-actual}} - \Delta T_{\text{zero-stored}})}{Q_m} * 100\%$$

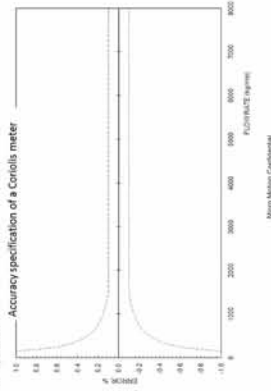

Micro Motion Confidential
Page 22



Zero Stability Specification

- The Zero Stability specification is used to specify how stable a flow meter is expected to behave, after zero setting.
- The Zero stability specification or from application specifics such as legal metrology
- The zero stability defines the smallest meaningful portion of flow in terms of meter stability and meter resolution.
 - Zero stability can be seen as an allowable *average* variation in flow measurement of a properly installed flow meter.
 - Flow readings smaller than the zero stability specification should not be interpreted as significant.



Micro Motion Confidential
Page 23



Zero Stability Specification

- Zero stability figures for each sensor type.
- Zero stability is expressed in flow engineering units (kg/h).
- Examples:
 - Zero stability of a CMF025 = ± 0.027 kg/h
 - Zero stability of a CMFHC3 = ± 136 kg/h



Micro Motion Confidential
Page 24



Flow meter Output Fluctuations

- Fluctuations at the flow meter output at no-flow are caused by variations in consecutive samples of ΔT_{meas} at no-flow condition

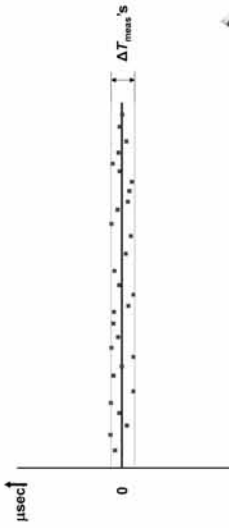

Micro Motion Confidential
Page 25



Flow Fluctuations

- As ΔT_{meas} samples are filtered before mass flow is calculated, the amplitude of the fluctuations are strongly dependent of the configured *damping*

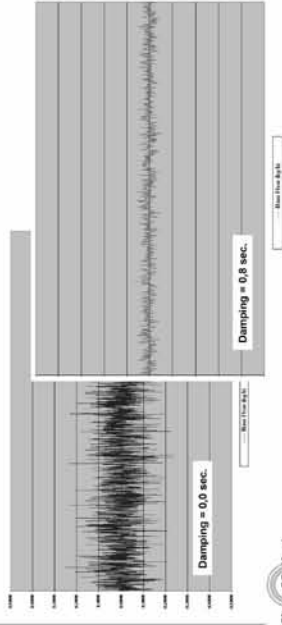

Micro Motion Confidential
Page 26

Zero Offset

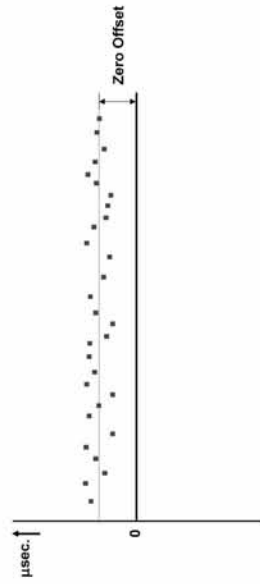

Micro Motion Confidential
Page 27



Agenda

- Zero phenomena
- Zero setting
- Zero verification



Micro Motion Confidential
Page 28



Zero Setting

- Zero offset can be compensated for by performing a ZERO SETTING
- Zero setting always to be performed at every new installation



Micro Motion

EMERSON
Process Management

Micro Motion Confidential
Page 25

Zero setting

Possible Sensor Orientations

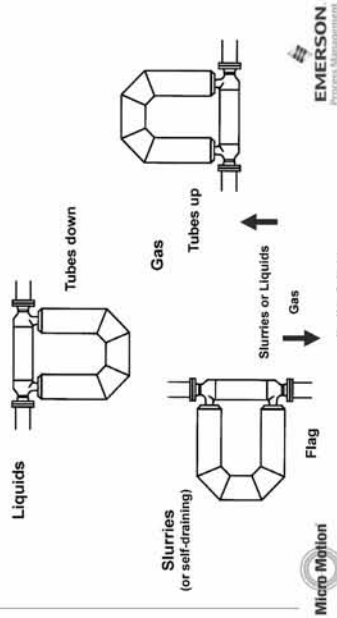

Micro Motion

EMERSON
Process Management

Micro Motion Confidential
Page 26

Zero setting

Recommended Sensor Installation

- Use common piping practices to eliminate torsion and bending
- Install a downstream valve for zeroing flowmeter
- Avoid excessive piping vibration
- Don't support the sensor by the case

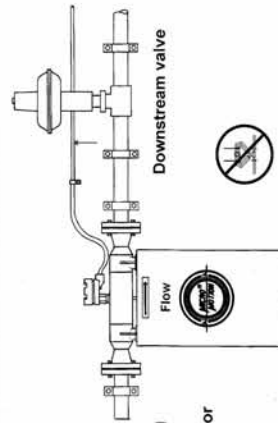

Micro Motion

EMERSON
Process Management

Micro Motion Confidential
Page 27

Zero setting needs installation measures

- Installation checks before performing a zero setting:
 - Is there a way to block the flow ?
 - block valves upstream and downstream of the sensor ?
 - If not, valve present at least downstream ?
 - Is valve positively shutting off ? (be careful: control valves are meant to control flow, not to positively shut off)
 - If there is no valve, where is the sensor located ?
 - Lowest point in the line ?
 - Highest point of the installation ?
 - If so, can we be sure that sensor remains full and that process fluid does not move in the sensor ?

The sensor must be kept full during zeroing
(Drive Gain < 70%)

Micro Motion

EMERSON
Process Management

Micro Motion Confidential
Page 28

Zero Setting: Application Issues

• Application checks before performing a zero setting:

- What are the fluid properties?
- Is the fluid vaporous?
 - Are we sure there is no out-gassing in the sensor?
 - Can the fluid be kept pressurized?
- Slurries or particles in the fluid?
 - Is installation preventing blocking of tubes?
 - Sedimentation may prevent us from being able to take a representative meter zero. Should we keep the factory zero?
 - Can we take the zero using water?
- Gas applications?
 - Are we positive that there is no accumulation of condensate or moisture in the sensor?



Micro Motion Confidential
Page 31



Basis Zero Setting Process

1. Always try to zero the meter under conditions close to normal operating conditions
 - Power transmitter for 30 minutes
 - Run process fluid through the sensor and make sure that temperature conditions are stable.

2. Stop the flow and block sensor section

- Flow **MUST** be zero
- Any leakage impairs calibration

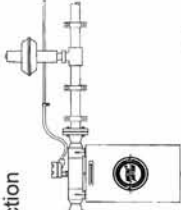

3. Start zero setting



Micro Motion Confidential
Page 32



Zero Setting / Zero stored

- During zero calibration the *average* of consecutive samples of ΔT_{meas} over a big number of tube-cycles is determined.
- This average is stored as $\Delta T_{\text{zero-stored}}$ in the transmitter memory. It is referred to as stored zero.

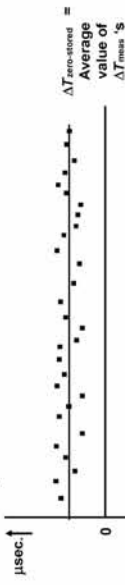

Micro Motion Confidential
Page 35



ZERO SETTING

- During normal operation, the transmitter subtracts the stored zero value ($\Delta T_{\text{zero-stored}}$) from the measured ΔT_{meas} samples and removes the offset.

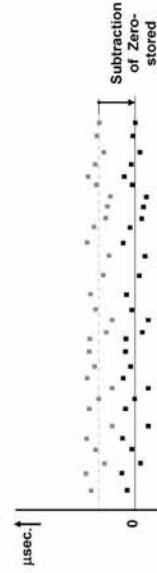

$$Q_m = FCF \times (\Delta T_{\text{meas}} - \Delta T_{\text{zero-stored}})$$



Micro Motion Confidential
Page 36



Zero Setting/Zero offset

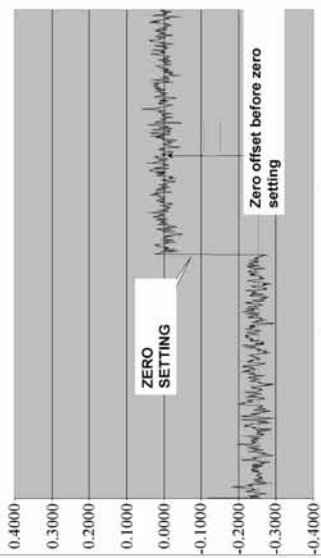

Micro Motion

Micro Motion Confidential
Page 27

EMERSON
Process Management

Zero setting

- Zero setting can compensate offset but it does not impact the output fluctuation.

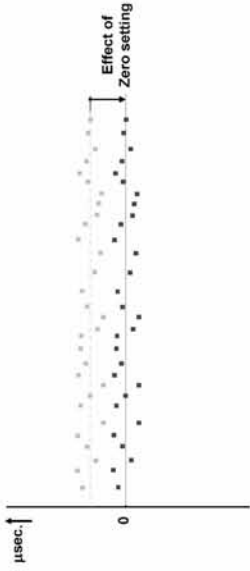

Micro Motion

Micro Motion Confidential
Page 28

EMERSON
Process Management

Zero Setting Using Prolink



Prolink is a very useful tool to perform and diagnose the auto zero process.

The Flow Calibration screen provides important parameters that allow us to do a sanity check on the outcome of the zeroing process:

- Zero
- Std. Dev.

The Flow Calibration screen also provides status and diagnostic information on the auto zero process.

Micro Motion

Micro Motion Confidential
Page 28

EMERSON
Process Management

Stored Zero and Std. Dev. Parameters



Zero is the stored meter zero value in microsecond ($\Delta T_{\text{stored-zero}}$), being the average value of consecutive ΔT_{meas} samples.

Standard deviation, a value that is representative for the variation in ΔT_{meas} samples around the average value ΔT_{stored} .

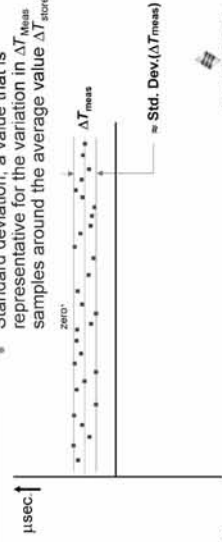

Micro Motion

Micro Motion Confidential
Page 29

EMERSON
Process Management

Standard Deviation

The *Standard Deviation* is a statistical value that represents the spread of the recorded data around the average value of all the data.

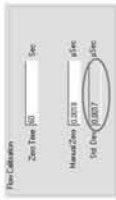

A high Standard Deviation in consecutive samples can be an indication for:

- Excessive external vibrations on the sensor
- Partially filled sensor tubes
- Entrained air
- Foreign materials in the tubes
- Blocked Tubes
- Dust in the tubes (if the tubes are empty)

As it is difficult to provide absolute numbers for a good standard deviations, it should be used with some care and in a comparative way!



Proper zero setting

- Perform zero setting three times in a row and analyse results on shift/trend and repeatability between the three results. Perform more zero settings if necessary.
- Possible leakage can be detected



Proper zero setting 3 settings in a row and analyse

Example1:

Sensor R100
Zero Stability Specification = 3.27 kg/h (= 0.91 g/s)
F.C.F. = 217.55 g/s/μsec.

3 consecutive Stored zero's are performed.

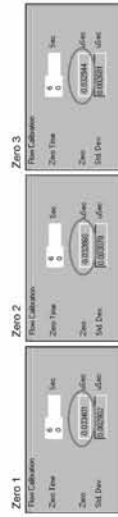

Diagnose Readings



Proper zero setting 3 settings in a row and analyse

Answer:

The variation in stored zero values:

$$\Delta(\Delta T_0) = (0.033401 - 0.032860) = 0.000541 \mu\text{sec}$$

This represents a variation in mass flow:

$$\Delta \text{ Mass Flow} = 0.000541 \times 217.55 = 0.12 \text{ g/s}$$

AND

The Std. Dev. values are stable (0.002902 – 0.003078 – 0.002681)

Zero is OK!



**Proper zero setting
3 settings in a row and analyse**

Example2:

Sensor CMF025
Zero Stability Specification = 0,027 kg/h (= 0,0076 g/s)
F.C.F. = 4,244 g/s/μsec.

3 consecutive Zero Calibrations are performed.

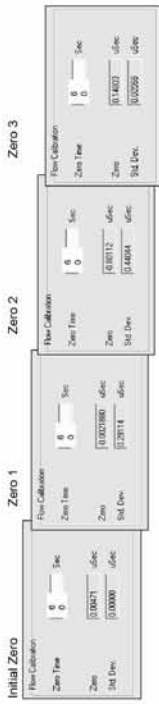

Diagnose Readings



EMERSON
Process Management

Micro Motion Confidential
Page 45



EMERSON
Process Management

Micro Motion Confidential
Page 46

**Proper zero setting
3 settings in a row and analyse**

Answer:

$\Delta(\Delta T_0) = (0,80112 - 0,002188) = 0,798932 \mu\text{sec}$

$\Delta \text{ Mass Flow} = 0,798932 \times 4,244 = 3,39 \text{ g/s}$

AND

The Std. Dev. values are instable (0,29114 – 0,44044 – 0,00568)

Zero is BAD !



EMERSON
Process Management

Micro Motion Confidential
Page 46

Zero Setting



A good Zero :

- Tells the sensor is correctly mounted
- Proves the sensor is correctly filled
- Is a **must** for accurate flow measurement



EMERSON
Process Management

Micro Motion Confidential
Page 45



EMERSON
Process Management

Micro Motion Confidential
Page 46

Zero Setting; OIML procedure

Auto Zero action No.	LAST BUT TWO	LAST BUT ONE	FINAL
Zero Value (kg)			
Standard Deviation (g)			
Sensor Temperature (°C)			
Sensor Density (kg/m³)			
Dens. Coeff (%)			

Zero value = (maximum zero - minimum zero) / Dev Coef Factor

Zero value = () * () * () * () * () * ()

Zero value = () * () * () * () * () * ()

The zero value should not exceed the manufacturer's specifications as mentioned in table below: YES / NO

Flow	Flow	Flow	Flow	Flow	Flow	Flow	Flow	Flow	Flow	Flow	Flow	Flow	Flow	Flow	Flow	Flow	Flow
100	1000	10000	100000	1000000	10000000	100000000	1000000000	10000000000	100000000000	1000000000000	10000000000000	100000000000000	1000000000000000	10000000000000000	100000000000000000	1000000000000000000	10000000000000000000



EMERSON
Process Management

Micro Motion Confidential
Page 46

Summary of zero setting

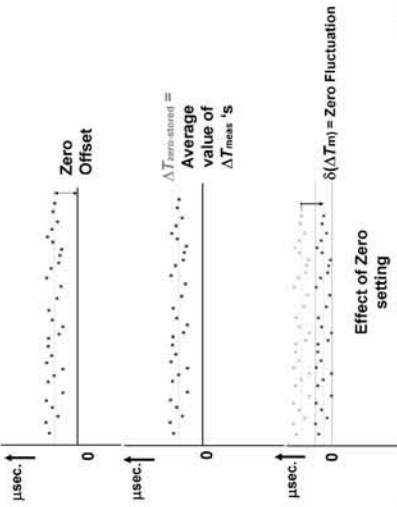

EMERSON
Process Management

Micro Motion Confidential
Page 49

Some Important Things to Note about Stored Meter Zero Values

- A new transmitter from stock will have a stored zero value of 0 μ seconds in it's memory.
- During factory calibration in the flow lab, the initial stored zero is determined and stored into the transmitter memory.
- Application issues may prevent you from capturing a proper zero setting in the field. In these cases it may be wise to keep the factory determined stored zero value. However, for custody transfer applications a proper zero is a MUST.



EMERSON
Process Management

Micro Motion Confidential
Page 50

Agenda

- Zero phenomena
- Zero setting
- Zero verification



EMERSON
Process Management

Micro Motion Confidential
Page 51

Zero Verification

- **Zero verification:**
Determining the average, observed zero flowrate, after initial zero setting and compare with applied zero stability specification (from manufacturer or dictated from application)
- Average, observed zero flowrate is determined (by **software or manually**) through monitoring the Mass Total at no flowconditions, during a longer period of time (usually 3 minutes) and calculate to kg/h or kg/min. The flow direction should be bi-directional and mass flow cut off set to zero.



EMERSON
Process Management

Micro Motion Confidential
Page 52

Zero Verification

3 methods for determining the average, observed zero flowrate:

- Direct: Field Verification Zero (FVZ)
Software calculates average observed flowrate (=FVZ) from totaliser increase over most recent 3 minutes with

direction and mass flow cut off to

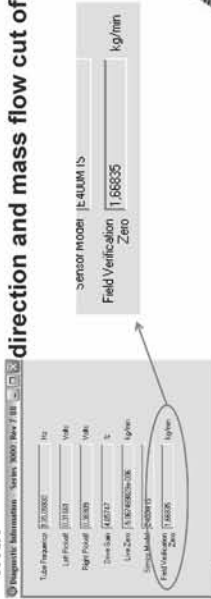

EMERSON
Process Management

Micro Motion Confidential
Page 53

Zero Verification

3 methods for zero verification:

- Via Live zero
Software calculates live zero from actual mass flow with a damping of 12 seconds; bi-directional flow direction and mass flow cut off to zero. Calculate manually average observed flowrate from average over 3 minutes (via Prolink)



EMERSON
Process Management

Micro Motion Confidential
Page 54

Zero Verification

3 methods for zero verification:

- Manually from totaliser
Monitor the difference of totaliser over 3 minutes, after setting flow direction to bi-directional and mass flow cut off to zero.
Calculate average observed flowrate from totaliser difference average over 3 minutes and convert to kg/min or kg/h

Not advisable:

- need to break possible sealing
- potential for “not setting back”



EMERSON
Process Management

Micro Motion Confidential
Page 55

Zero verification

Zero verification:
Manually from totaliser

1. Configure:
 - the Flow Direction Bi-Directional
 - the Flow Damp at 0.80 sec
 - the Mass Flow Cutoff at 0.00000
2. Reset the Mass totalizer
3. After 3 minutes, record the Mass totalizer value
4. Multiply the measured Mass totalizer value with 20 (=average observed zero flow) to convert to kg/h

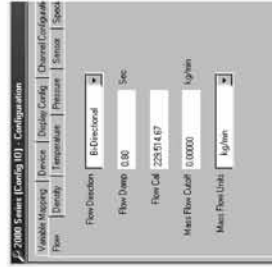

EMERSON
Process Management

Micro Motion Confidential
Page 56

Zero verification

- While recording, it may be useful to measure more process variables (density and temperature) and diagnostic values (pick-off amplitudes, drive gain) for reference and analysis.
- Most of the times we will find that the reading of the actual flow fluctuation is *higher* than the average observed zero flowrate. This is typical as fluctuation is an instantaneous effect and average, observed flowrate an averaging effect.



Micro Motion Confidential
Page 37



Zero verification acc. Micro Motion



Make sure that flow is zero.
Record from Protek:
Zero stored water from electronics: _____ sec
Sensor Temp: _____ °C
Sensor Density: _____ g/cc
Drive gain: _____ % (DO < 70%)

A. Use field verification zero (VZ), expressed in lightm, to determine the Observed Zero Flow
OR

B. Use Protek. It is to determine the Observed Zero Flow by accumulating total over 2 minutes. Flow direction is directional.
Low Flow Cutoff = 4. Divide the outcome with 3 to get the Observed Zero Flow value in lightm:

Observed Zero Flow = _____ lightm

Calculate the Observed Zero Flow effect

Assume Q_{obs} = _____ lightm

Average Observed Zero Flow (lightm) / (Q rate [lightm] x 100%) x 100% = _____ %

The average observed zero flow should not exceed 10% for zero flow effect for applicable cases.

Class	Max. Permissible errors on zero flow effect (%)	
	Lightm	Lightm / Liquid
Class	0.3	0.5
Observed Zero Flow effect on Q rate	0.1	0.2
Accuracy, total IME meter	0.2	0.3
		0.9
		1.5

FEU/LI/LLI CRITERIA: YES/NO

Make sure that flow is zero.
Record from Protek:
Zero stored water from electronics: _____ sec
Sensor Temp: _____ °C
Sensor Density: _____ g/cc
Drive gain: _____ % (DO < 70%)

A. Use field verification zero (VZ), expressed in lightm, to determine the Observed Zero Flow
OR

B. Use Protek. It is to determine the Observed Zero Flow by accumulating total over 2 minutes. Flow direction is directional.
Low Flow Cutoff = 4. Divide the outcome with 3 to get the Observed Zero Flow value in lightm:

Observed Zero Flow = _____ lightm

Calculate the Observed Zero Flow effect

Assume Q_{obs} = _____ lightm

Average Observed Zero Flow (lightm) / (Q rate [lightm] x 100%) x 100% = _____ %

The average observed zero flow should not exceed 10% for zero flow effect for applicable cases.

Class	Max. Permissible errors on zero flow effect (%)	
	Lightm	Lightm / Liquid
Class	0.3	0.5
Observed Zero Flow effect on Q rate	0.1	0.2
Accuracy, total IME meter	0.2	0.3
		0.9
		1.5

FEU/LI/LLI CRITERIA: YES/NO

Zero Stability Test (Logging)

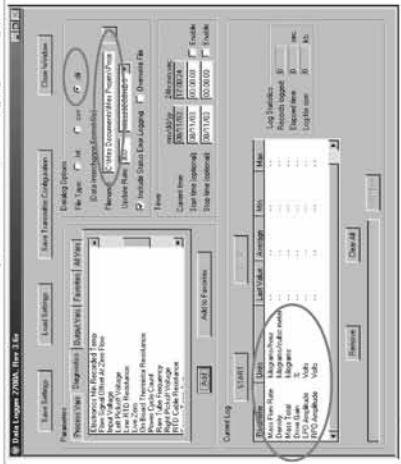

Start the Data Logging and choose the parameters to be monitored:

- Mass Flow Rate
- Mass Total
- Density
- LPO/RPO amplitudes
- Drive Gain



Micro Motion Confidential
Page 39



Zero Stability Test (Logging)

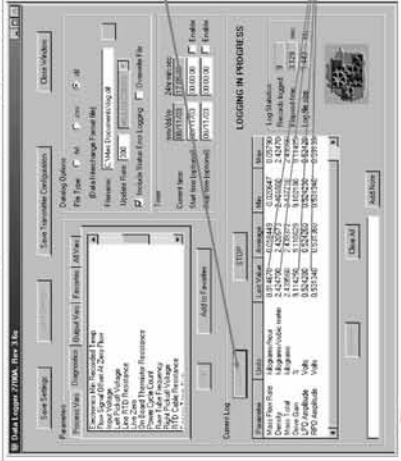

Start the Data Logging registration.

Measured values



Micro Motion Confidential
Page 40



Testing the Zero Stability of the meter

Example2:

Sensor: CMF025
 Z.S.Spec: 0.027 kg/h
 Fluid: Water
 Test time: 15 minutes
 Parameter: Mass Total

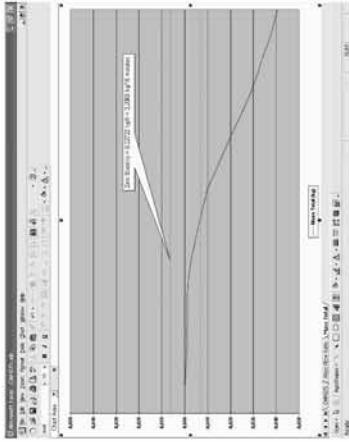

Testing the Zero Stability of the System

Example2:

Sensor: CMF025
 Z.S.Spec: 0.027 kg/h
 Fluid: Water
 Test time: 15 minutes
 Parameter: Mass Flow

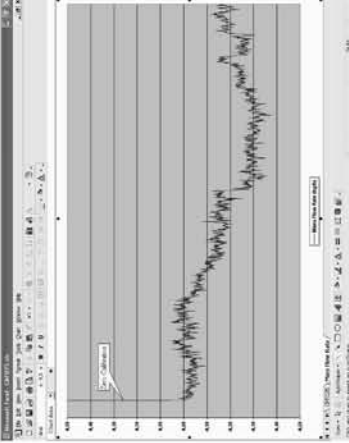

Zero Drift

- The last example shows a behaviour that is known as Zero Drift.
- What to do in case of zero drift?
 - DO NOT make any further zero calibrations without prior investigation
 - Try to collect diagnostic informations
 - Run some flow in the sensor
 - Stop the flow and observe the flow reading at no-flow condition

Summary

- Coriolis meter may already measure mass flow when there is no flow
- Zero setting is a must after every new installation.
- Also any (re)calibration
- Zero setting results in new stored zero
- Proper zero setting at least three times
- Zero setting can only be performed by breaking the seal in custody transfer applications

Summary

- Zero verification is comparing the average, observed zero mass flow, after zero setting, with manufacturer's zero stability or with criteria coming from application such as custody transfer
- Zero verification can be performed without breaking the seal



Any Questions?



Agenda practical session

- Global Calibration Traceability of Micro Motion
- Coriolis equations by Micro Motion
- All subjects related to zero
- Explain water calibration/configuration sheet
- Exercises



Micro Motion, Inc. **Mass Flowmeter Calibration Certificate** **12022089**

Product Code: CFC039596Z8Z33X Serial ID: 12022089 Order ID: 33149054 Size: 250 Item: 1 Customer: Tsg

Process ID: 2.174549C Flow Unit: g/min Date: 9/20/13

Process Standard: ISO 9188:2002 Standard Uncertainty: +/- 0.03%

Plant: RRD Flow Direction: 100%

ISA Rate: 2450 R/MIN Inlet Temp: 15.11 °C Outlet Temp: 21.3 °C

Station: 10255 Meter ID: 10211 K1: 5855.678 K2: 6884.250 IM: 7.7476 IMR: 14.628 zero: 0 zero: 0 zero: 0 zero: 0 zero: 0 zero: 0

Flowcell: 4646.42.79 PFM: 0 PFM: 0 Demark: 1.0285026842.75 PCF: 4646.4 PT: 2.79

SIEMENS, R. 75.5 1846.995 1874.34 1873.980 0.018 0.090 0.000 0.000

Technician 75.5 1846.995 1874.055 1875.014 0.013 0.090 0.000 0.000

Traceable to International Standards. Meter data based on pulse output. Details at www.micro-motion.com 2013.11.30 14:11:55 1/2

Flow (g/min)	Flow Rate	Total	Offset	Specification
8.4	205.065	361.179	360.632	0.146
8.4	205.065	360.6155	360.3062	0.3093
24.5	599.76	607.3183	607.3064	0.0002
24.5	599.76	606.1137	606.2308	-0.019
24.5	599.76	605.0928	605.6077	0.004
24.5	599.76	605.0928	605.6077	0.004
51.0	1248.89	1255.786	1255.864	-0.014
51.0	1248.89	1267.279	1267.439	-0.013
75.5	1846.995	1874.34	1873.980	0.018
75.5	1846.995	1874.055	1875.014	0.013
75.5	1846.995	1875.418	1875.164	0.014
75.5	1846.995	1875.418	1875.164	0.014

Transmitter Configuration Report

Product Code: 09002829
 Order ID: 15080147
 Line Item: 3 12
 Customer Tag: 6

Serial ID: 13224110
 Order ID: 15080147

Process ID: 12143308
 Process Time: 2008-01-25 20:10:33
 Process Stand: SPC-COMFIG16ESC

Special Mass Flow Rate: NONE
 Special Volume Base Unit: LITER
 Special Volume Conv Factor: 1
 Special Volume Flow Rate: NONE
 Special Volume Flow Unit: NONE
 Special Volume Flow Rate: NONE
 Special Volume Flow Unit: NONE
 Special Volume Flow Rate: NONE
 Special Volume Flow Unit: NONE
 Special Volume Flow Rate: NONE
 Special Volume Flow Unit: NONE
 Special Volume Flow Rate: NONE
 Special Volume Flow Unit: NONE
 Special Volume Flow Rate: NONE
 Special Volume Flow Unit: NONE

JWD Channel Assignments
 Channel A Assignment: FREQUENCY 1
 Channel B Assignment: INTERNAL
 Channel C Assignment: NONE

Discrete Inputs
 Discrete Input 1 Assignment: NONE
 Discrete Output 1 Assignment: FAULT
 Discrete Output 2 Assignment: NONE
 Discrete Output 3 Assignment: NONE
 Discrete Output 4 Assignment: NONE
 Discrete Output 5 Assignment: NONE
 Discrete Output 6 Assignment: NONE
 Discrete Output 7 Assignment: NONE
 Discrete Output 8 Assignment: NONE
 Discrete Output 9 Assignment: NONE
 Discrete Output 10 Assignment: NONE

Frequency Rolling Method: FREQUENCY/FLOW
 Frequency Variable: NEG FLOW RATE
 Frequency Variable: POS FLOW RATE
 Frequency Variable: NEG FLOW RATE
 Frequency Variable: POS FLOW RATE

Event 1 Setpoint: 0
 Event 1 Type: LOW ALARM
 Event 1 Frequency: 1000
 Event 2 Setpoint: 0
 Event 2 Type: HIGH ALARM
 Event 2 Frequency: 1000

Frequency Rate: 18.1037
 Frequency Unit/ Pulse: 0.00002395
 Special Mass Flow Rate: NONE
 Special Mass Flow Unit: SEC
 Special Mass Flow Rate: NONE
 Special Mass Flow Unit: SEC

2012.07.07 16:01:02 172

Density calibration sheet: FT/DT determination for high/low temperatures

EMERSON
 Process Management

Micro Motion
 Process Management

Product Code: 09002829
 Order ID: 15080147
 Line Item: 3 12
 Customer Tag: 6

Serial ID: 13224110
 Order ID: 15080147

Process ID: 12143308
 Process Time: 2008-01-25 20:10:33
 Process Stand: SPC-COMFIG16ESC

Special Mass Flow Rate: NONE
 Special Volume Base Unit: LITER
 Special Volume Conv Factor: 1
 Special Volume Flow Rate: NONE
 Special Volume Flow Unit: NONE
 Special Volume Flow Rate: NONE
 Special Volume Flow Unit: NONE
 Special Volume Flow Rate: NONE
 Special Volume Flow Unit: NONE
 Special Volume Flow Rate: NONE
 Special Volume Flow Unit: NONE
 Special Volume Flow Rate: NONE
 Special Volume Flow Unit: NONE
 Special Volume Flow Rate: NONE
 Special Volume Flow Unit: NONE

JWD Channel Assignments
 Channel A Assignment: FREQUENCY 1
 Channel B Assignment: INTERNAL
 Channel C Assignment: NONE

Discrete Inputs
 Discrete Input 1 Assignment: NONE
 Discrete Output 1 Assignment: FAULT
 Discrete Output 2 Assignment: NONE
 Discrete Output 3 Assignment: NONE
 Discrete Output 4 Assignment: NONE
 Discrete Output 5 Assignment: NONE
 Discrete Output 6 Assignment: NONE
 Discrete Output 7 Assignment: NONE
 Discrete Output 8 Assignment: NONE
 Discrete Output 9 Assignment: NONE
 Discrete Output 10 Assignment: NONE

Frequency Rolling Method: FREQUENCY/FLOW
 Frequency Variable: NEG FLOW RATE
 Frequency Variable: POS FLOW RATE
 Frequency Variable: NEG FLOW RATE
 Frequency Variable: POS FLOW RATE

Event 1 Setpoint: 0
 Event 1 Type: LOW ALARM
 Event 1 Frequency: 1000
 Event 2 Setpoint: 0
 Event 2 Type: HIGH ALARM
 Event 2 Frequency: 1000

Frequency Rate: 18.1037
 Frequency Unit/ Pulse: 0.00002395
 Special Mass Flow Rate: NONE
 Special Mass Flow Unit: SEC
 Special Mass Flow Rate: NONE
 Special Mass Flow Unit: SEC

2012.07.07 16:01:02 172

Micro Motion, Inc. 09002829

Transmitter Configuration Report

Frequency Fault Behavior: DOWNSCALE
 Frequency Fault Value: 15000
 R4885 Fault Behavior: NONE
 mAl Fault Behavior: DOWNSCALE
 mAl Fault Value: 2

Other
 Calibration Process ID: 12242008
 Density Cutoff: 0.2
 Density Damping: 0.64
 Density High Limit: 5
 Density Low Limit: 0
 Direction: FORWARD
 Fault Dwell Time: 0
 Feature Key: 2046
 Flow Damping: 0.64
 MFG: 09002829
 Mass Flow Cutoff: 0.00184
 Pressure Comp Line Pressure: 0
 Pressure Compensation State: OFF
 Slurp Duration: 0
 Tag:
 Temperature Damping: 2.4
 Transmitter Software Rev: 140
 Volume Flow Cutoff: 0.00184

2012.07.07 16:01:02 172

Micro Motion
 Process Management

EMERSON
 Process Management

Product Code: 09002829
 Order ID: 15080147
 Line Item: 3 12
 Customer Tag: 6

Serial ID: 13224110
 Order ID: 15080147

Process ID: 12143308
 Process Time: 2008-01-25 20:10:33
 Process Stand: SPC-COMFIG16ESC

Special Mass Flow Rate: NONE
 Special Volume Base Unit: LITER
 Special Volume Conv Factor: 1
 Special Volume Flow Rate: NONE
 Special Volume Flow Unit: NONE
 Special Volume Flow Rate: NONE
 Special Volume Flow Unit: NONE
 Special Volume Flow Rate: NONE
 Special Volume Flow Unit: NONE
 Special Volume Flow Rate: NONE
 Special Volume Flow Unit: NONE
 Special Volume Flow Rate: NONE
 Special Volume Flow Unit: NONE
 Special Volume Flow Rate: NONE
 Special Volume Flow Unit: NONE

JWD Channel Assignments
 Channel A Assignment: FREQUENCY 1
 Channel B Assignment: INTERNAL
 Channel C Assignment: NONE

Discrete Inputs
 Discrete Input 1 Assignment: NONE
 Discrete Output 1 Assignment: FAULT
 Discrete Output 2 Assignment: NONE
 Discrete Output 3 Assignment: NONE
 Discrete Output 4 Assignment: NONE
 Discrete Output 5 Assignment: NONE
 Discrete Output 6 Assignment: NONE
 Discrete Output 7 Assignment: NONE
 Discrete Output 8 Assignment: NONE
 Discrete Output 9 Assignment: NONE
 Discrete Output 10 Assignment: NONE

Frequency Rolling Method: FREQUENCY/FLOW
 Frequency Variable: NEG FLOW RATE
 Frequency Variable: POS FLOW RATE
 Frequency Variable: NEG FLOW RATE
 Frequency Variable: POS FLOW RATE

Event 1 Setpoint: 0
 Event 1 Type: LOW ALARM
 Event 1 Frequency: 1000
 Event 2 Setpoint: 0
 Event 2 Type: HIGH ALARM
 Event 2 Frequency: 1000

Frequency Rate: 18.1037
 Frequency Unit/ Pulse: 0.00002395
 Special Mass Flow Rate: NONE
 Special Mass Flow Unit: SEC
 Special Mass Flow Rate: NONE
 Special Mass Flow Unit: SEC

2012.07.07 16:01:02 172

Micro Motion
 Process Management

EMERSON
 Process Management

Product Code: 09002829
 Order ID: 15080147
 Line Item: 3 12
 Customer Tag: 6

Serial ID: 13224110
 Order ID: 15080147

Process ID: 12143308
 Process Time: 2008-01-25 20:10:33
 Process Stand: SPC-COMFIG16ESC

Special Mass Flow Rate: NONE
 Special Volume Base Unit: LITER
 Special Volume Conv Factor: 1
 Special Volume Flow Rate: NONE
 Special Volume Flow Unit: NONE
 Special Volume Flow Rate: NONE
 Special Volume Flow Unit: NONE
 Special Volume Flow Rate: NONE
 Special Volume Flow Unit: NONE
 Special Volume Flow Rate: NONE
 Special Volume Flow Unit: NONE
 Special Volume Flow Rate: NONE
 Special Volume Flow Unit: NONE
 Special Volume Flow Rate: NONE
 Special Volume Flow Unit: NONE

JWD Channel Assignments
 Channel A Assignment: FREQUENCY 1
 Channel B Assignment: INTERNAL
 Channel C Assignment: NONE

Discrete Inputs
 Discrete Input 1 Assignment: NONE
 Discrete Output 1 Assignment: FAULT
 Discrete Output 2 Assignment: NONE
 Discrete Output 3 Assignment: NONE
 Discrete Output 4 Assignment: NONE
 Discrete Output 5 Assignment: NONE
 Discrete Output 6 Assignment: NONE
 Discrete Output 7 Assignment: NONE
 Discrete Output 8 Assignment: NONE
 Discrete Output 9 Assignment: NONE
 Discrete Output 10 Assignment: NONE

Frequency Rolling Method: FREQUENCY/FLOW
 Frequency Variable: NEG FLOW RATE
 Frequency Variable: POS FLOW RATE
 Frequency Variable: NEG FLOW RATE
 Frequency Variable: POS FLOW RATE

Event 1 Setpoint: 0
 Event 1 Type: LOW ALARM
 Event 1 Frequency: 1000
 Event 2 Setpoint: 0
 Event 2 Type: HIGH ALARM
 Event 2 Frequency: 1000

Frequency Rate: 18.1037
 Frequency Unit/ Pulse: 0.00002395
 Special Mass Flow Rate: NONE
 Special Mass Flow Unit: SEC
 Special Mass Flow Rate: NONE
 Special Mass Flow Unit: SEC

2012.07.07 16:01:02 172

Agenda practical session

- Global Calibration Traceability of Micro Motion
- Coriolis equations by Micro Motion
- All subjects related to zero
- Explain water calibration/configuration sheet
- Exercises



More Motion Confidential
Page 77



Agenda practical session

Exercises

Group divided in 4 subgroups for the 4 exercises:
Demo 1: Calibration of a mass flow meter (zero not included) and effect of mass flow cut off
Demo 2: Performing a proper and improper zero setting
Demo 3: Effect on accuracy in mass and density due to corrosion/erosion/shift temperature
Demo 4: Verification of settings and sealing facility

First at each demo, 15 minutes explanation of Prolink start exercise for 30 minutes; rotate to other demo
Total: 2 h 15 min



More Motion Confidential
Page 78



Route to OIML compliance of Micro Motion for marine applications

APLFM conference
July 6 - 9, 2010
Singapore

by
Aart Pruysen
Approval Director Europe



Agenda

- 1 Scope of the bunker approval
- 2 Obtained approvals before starting with the bunker approval
- 3 Bunker fuel tests
- 4 Release of the bunker approval



Agenda

- 1 Scope of the bunker approval
- 2 Obtained approvals before starting with the bunker approval
- 3 Bunker fuel tests
- 4 Release of the bunker approval



1. Scope

"Bunker application"

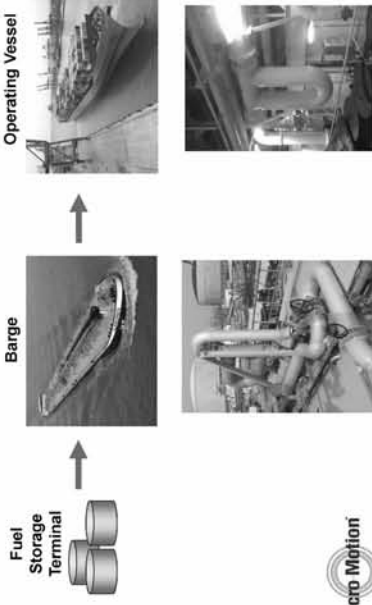

1. Scope

- "Bunker application"
- meter on barge
 - * to receive from land or other barges (loading)
 - * to deliver to vessels (discharging)
 - meter on vessel to receive from barges



1. Scope

Why flowmetering of bunker fuel?

Advantages of using a flow meter in stead of barge tank measurements (soundings):

- decrease of bunkering time (no time consuming barge tank soundings at start and end)
- meter is close to transfer point (quantity determination not influenced by big volumes measurement between barge tanks and transfer point)
- no manual entries (i.e. manual dip)
- tamper proof (electric and mechanical integrity)

Mass flow meters indicate "mass in vacuo" (not conventional mass/"mass in air")

1. Scope

Two main characteristics of bunker fuel application:

- High viscous/high temperature liquid
- Air entrainment is likely to occur (air in the meter)



1. Scope

- Bunker fuel characteristics
 - high viscosity
 - bunker fuel temperatures higher than ambient (up till 60 °C)
- Bunker fuels according ISO 8217
 - Viscosities up till 850 cSt at 50 °C (higher than from ISO 8217) have been already noted

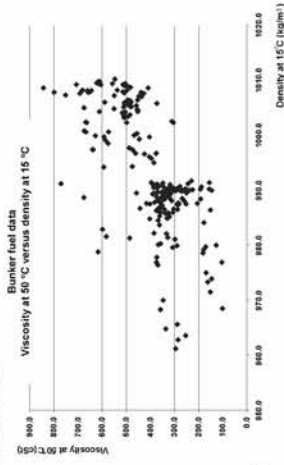

1. Scope

Two main characteristics of bunker fuel application:

- High viscous/high temperature liquid
- Air entrainment is likely to occur (air in the meter)



1. Bunker specifics

Accuracy class 0.5 for the “meter, non aerated”:
line B: 0.3%

Table 2

	Accuracy class	
Line B	0.3	0.5
A (*)	0.3 %	0.5 %
B (*)	0.5 %	1.0 %
C (equal to Line A - Line B)	0.2 %	0.3 %
Line A - Line B	0.1 %	0.2 %
	0.4 %	0.5 %

(*) see 2.6 for application of line A or line B.

3.1.9 Measuring systems equipped with mass flowmeters

3.1.9.1 The requirements in 3.1.5.1 to 3.1.5.4 apply.

3.1.9.2 The mass flowmeter shall be installed in the measuring system in accordance with the system manufacturer’s recommendations and with any conditions or limitations set out in the type approval certificate.



1. Scope

- Bunker application includes several types of air entrainment:
 - “defined” air to fill/empty pipework
 - stripping (emptying barge tank ; temporarily)
 - blended air (could be continuous)



1. Scope

- Aeration likely to occur for a bunker application “filling/emptying pipeworks”

Ideal test nr. 1 on Victrol Antwerp barge
14 April 09 from 10.60 till 11.13 hours



1. Scope

- Aeration likely to occur for a bunker application: “stripping at end”

B.L.: Victrol Antwerp typical bunkering on 9 Feb 2010 with HCl2 (40,10%)
530 ton LP580 high sulphure

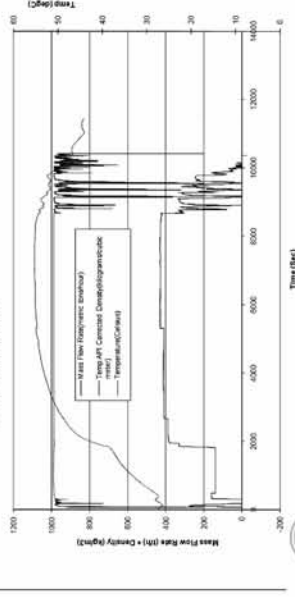

1. Scope

- Aeration likely to occur for a bunker application “filling/emptying pipeworks”

Ideal test nr. 1 on Victrol Antwerp barge
14 April 09 from 10.60 till 11.13 hours

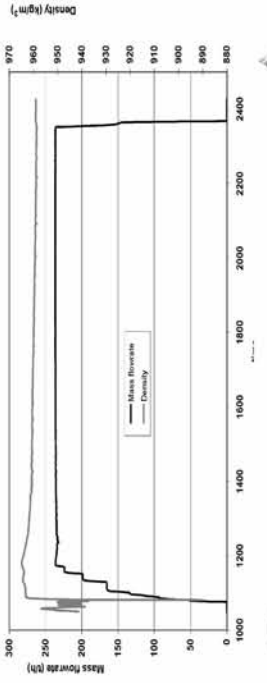

1. Scope

- Aeration likely to occur for a bunker application: “stripping at end”

B.L.: Victrol Antwerp typical bunkering on 9 Feb 2010 with HCl2 (40,10%)
530 ton LP580 high sulphure

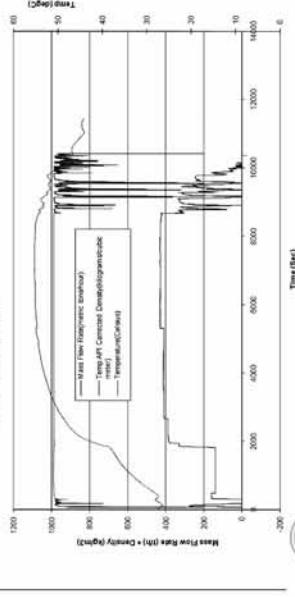

1. Scope

- Aeration likely to occur for a bunker application: “bunker fuel with blended air”

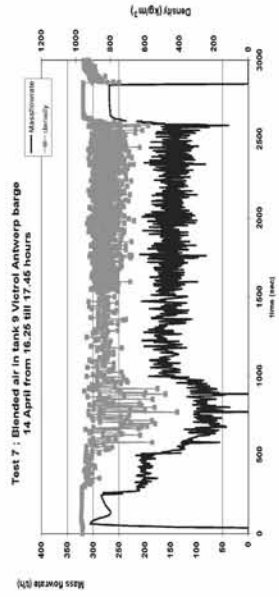

1. Scope

From OIML R117-1:

2.10 Elimination of air or gases

2.10.4 Viscous liquids

Since the effectiveness of gas elimination devices decreases as the viscosity of the liquids increases, these devices are not required for measuring liquids with a dynamic viscosity of more than 20 mPa·s at 20 °C.

Measuring system will not have an air elimination device, but the meter will be exposed with air.

How to deal with this acc. OIML R117-1?



1. Scope

Deviations from OIML R 117-1 for bunkering are allowed

From scope of OIML R 117-1:

This Recommendation is not intended to prevent the development of new technologies.

Alternatives to "air elimination device" or "intermediate tank" are possible such as "aeration diagnostic tool"

Alternatives are also subject to type approval for the "bunkering approval"



1. Scope

Bunker approval to include:

- Only mass (not volume or standard volume)
- Measuring system on a barge to receive or/and to deliver
- Measuring system on a vessel to receive
- Aeration diagnostic tool to detect (not correct) non-allowable uncertainty in mass due to aeration



1. Scope

Needed accomplishments:

- Perform tests with bunker fuel without aeration to prove 0.3% accuracy
- Perform tests to quantify the effect on mass accuracy due to the three types of aeration
- Develop software for the aeration diagnostic tool
- Assessment of aeration software
- Perform real bunkerings



Agenda

- 1 Scope of the bunker approval
- 2 Obtained approvals before starting with the bunker approval
- 3 Bunker fuel tests
- 4 Release of the bunker approval



2. Obtained approvals

Approval for meter only

The meter is a constituent element of the measuring system, and therefore a type approval is possible acc. clause 6.1.1 of OIML R117-1.

The European Directive MID (Measuring Instruments Directive) does not recognize constituent elements. It is up to the manufacturer to apply for a MID compliant component certificate of a measuring system under his responsibility ("voluntary approach"). This certificate is called "Evaluation Certificate" or "Parts Certificate".

MID compliant means also OIML R117-1 compliant



2. Obtained approvals

Approval for "meter only"

Following subjects are examined for "meter only":

- Accuracy tests (acc. line B)
- Functionality tests
- Influence tests and disturbance tests
- Readability of indication
- Possibility of foreseeable fraude
- Sealing
- Nameplate

Two evaluation certificates obtained from Nmi: TC7056 for all CMF sensors and TC 7057 for all electronics

Note: TC7056 is only referring to MID but it meets also OIML R117-1



Evaluation certificate

Issued by: NMI Center B.V.
in accordance with: MID Directive 2008/90/EC (MID) and OIML R117-1
Applicant: Emerson Process Management (EPM) B.V.
in report of: The manufacturer
Characteristics: Mass Motion
Minimum required quantity: 1000 units
Measurement rate: 1 Hz
Temperature range liquid: -200 °C to +200 °C for all other states
Temperature range solid: -10 °C to +35 °C
Identification label attached: Yes
Intended for the measurement of: Mass flow

Remarks: The manufacturer (EPM) is responsible for the conformity of the product with the requirements of the MID Directive and OIML R117-1. The manufacturer (EPM) is responsible for the conformity of the product with the requirements of the MID Directive and OIML R117-1. The manufacturer (EPM) is responsible for the conformity of the product with the requirements of the MID Directive and OIML R117-1.

Signature and stamp of the manufacturer (EPM) B.V.

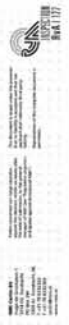

Evaluation certificate

Issued by: NMI Center B.V.
in accordance with: MID Directive 2008/90/EC (MID) and OIML R117-1
Applicant: Emerson Process Management (EPM) B.V.
in report of: The manufacturer
Characteristics: Mass Motion
Minimum required quantity: 1000 units
Measurement rate: 1 Hz
Temperature range liquid: -200 °C to +200 °C for all other states
Temperature range solid: -10 °C to +35 °C
Identification label attached: Yes
Intended for the measurement of: Mass flow

Remarks: The manufacturer (EPM) is responsible for the conformity of the product with the requirements of the MID Directive and OIML R117-1. The manufacturer (EPM) is responsible for the conformity of the product with the requirements of the MID Directive and OIML R117-1. The manufacturer (EPM) is responsible for the conformity of the product with the requirements of the MID Directive and OIML R117-1.

Signature and stamp of the manufacturer (EPM) B.V.



2. Obtained approvals

Approval for complete measuring system, without air entrainment

User has to take measures to avoid air entrainment

M

2. Obtained approvals

Approval for complete measuring system, without air entrainment

Following subjects are examined for a system:
 — Making use of only OIML/MID compliant components such as the meter; flowcomputer; pressure; temperature etc.



CMF sensors
 Micro Motion

S600
 RAS

3144P
 Rosemount

3051S



2. Obtained approvals

Approval for complete measuring system, without air entrainment

Following subjects are examined for a system (continued):
 — Scope (where ends the W&M interference)



2. Obtained approvals

• Typical measurement set up:

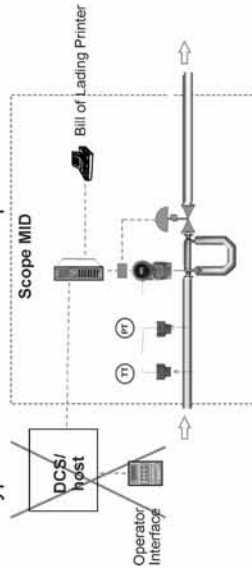

• Scope includes CT display; local printer; memory etc.
 — Liquid: measuring system (incl. pipework; valves etc.)

• Emerson strategy:
 Do not include DCS; host/management computers which generate the invoices



2. Obtained approvals

Approval for complete measuring system, without air entrainment

Following subjects are examined for a system (continued):
 — Integrity of measuring system (by-passes; tappings between meter and transfer point etc.)
 — Measures to avoid air entrainment
 — Sealing
 — Nameplate

A EC type examination certificate T 10071 has been obtained from NMI for a “generic” measuring





EC-type examination certificate

Number T10071-00003-3
Page 1 of 1

Issued by
M&C Ceram S.p.A.
Manufacturer
Emerson Process Management Italia S.p.A.
Measuring instrument
Air flowmeter for non-cyclonic measuring instrument for liquids

When used under
Type
M&C 1000
Material
Stainless steel

Measurement status
Type
M&C 1000
Material
Stainless steel

Temperature range (liquid)
Type
M&C 1000
Material
Stainless steel

Temperature range (gas)
Type
M&C 1000
Material
Stainless steel

Further particulars are indicated
by the following references:
- Documentation T10071-3

Valid until
Remarks
21 April 2017

Issuing Authority
M&C Ceram S.p.A., notified body number 0333
E Line 100

EMERSON
Process Management

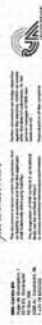

2. Obtained approvals

Approval for complete measuring system, with air entrainment in the system but not in the meter
Same as T10071 but now also including a MID compliant air eliminator to avoid air entrainment in the meter

A EC type examination certificate T 10255 has been obtained from NMI for a "generic" measuring system



EC type-examination certificate

Number T10071-00003-3
Page 1 of 1

Issued by
M&C Ceram S.p.A.
Manufacturer
Emerson Process Management Italia S.p.A.
Measuring instrument
Air flowmeter for non-cyclonic measuring instrument for liquids

When used under
Type
M&C 1000
Material
Stainless steel

Measurement status
Type
M&C 1000
Material
Stainless steel

Temperature range (liquid)
Type
M&C 1000
Material
Stainless steel

Temperature range (gas)
Type
M&C 1000
Material
Stainless steel

Further particulars are indicated
by the following references:
- Documentation T10071-3

Valid until
Remarks
21 April 2017

Issuing Authority
M&C Ceram S.p.A., notified body number 0333
E Line 100

EMERSON
Process Management

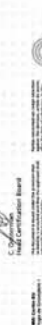

Agenda

- 1 Scope of the bunker approval
- 2 Obtained approvals before starting with the bunker approval
- 3 Bunker fuel tests
- 4 Release of the bunker approval



3. Bunker fuel tests

Test schedule (testplan 1 ; 2 and 3) were developed with the objectives:

- 1.1 accuracy of HC₃ with heavy fuel oil under ideal conditions (testplan 1)
- 1.2 accuracy of a HC₃ measuring system as receiving on a barge, starting and ending with empty pipeworks with defined flushing conditions and calibration of the Antwerp barge tank measurement system of Victrol
- 1.3 accuracy of a HC₃ measuring system on board of a bunker barge, includes quantifying stripping of barge tank (testplan 2)
- 3 accuracy of a HC₃ measuring system on board of a vessel (testplan 3)



3. Bunker fuel tests

42 Official tests (witnessed by Nmi) were performed in period March 2009 – April 2010

Testplan 1:

- 1.1 18 ideal tests
- 1.2 9 barge loading tests (start and end with empty pipes)
- 1.3 uncertainty of Victrol Antwerp tanks determined

Testplan 2:

- 2.1 7 tests, representing "normal bunkering by Victrol Antwerp"
- 2.2 5 only stripping tests
- 2.3 quantify remaining liquid between meter and transferpoint

Testplan 3:

- 3 bunkering resi with HC3 meter on vessel



3. Bunker fuel tests

Testplan 1:

- 1.1 18 ideal tests
- 1.2 9 barge loading tests (start and end with empty pipes)
- 1.3 uncertainty of Victrol Antwerp tanks determined

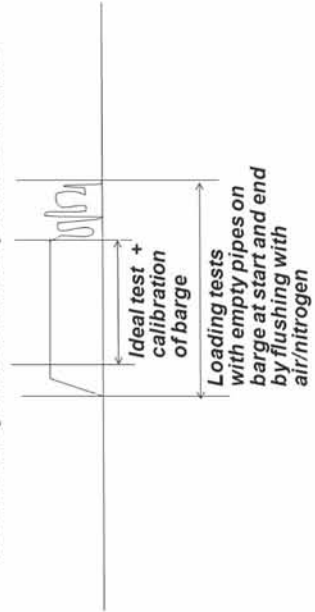

3. Bunker fuel tests

Testplan 1:

- 1.1 All 18 ideal tests < 0.3%
- 1.2 All 9 barge loading tests < 0.5%



3. Bunker fuel tests

Determine the uncertainty of Victrol barge tanks, based on print-out of tank measurement system and immersed temperature element

test nr.	Delivered Esso reference mass (kg)	Antwerp barge mass acc. print-out	Error mass barge tank-Esso (%)	tanks involved
test 1	238973,96	239092,2639	0,2147	1,3,7,10
test 2	221321,42	221068,3530	-0,1410	1,3,7,10
test 3	329285,46	32890,5252	0,0898	1,3,7,10
test 4	318496,88	31886,7610	0,0339	4;6;9
test 5	221027,24	22037,6467	-0,1039	4;6;9
test 6	249207,7228	249396,5656	0,0758	3,4;6;7;9
		Average barge (%)	0,03	
		2 s dev. (%)	0,11	
		On-site uncertainty (%)	0,10	
		Comb. expanded uncertainty (%)	0,15	

Victrol barge tank: 0.2% uncertainty overall



3. Bunker fuel tests

Test 2.1 :
All 7 real bunkerings with HC3 meter on barge < 0.5%

Difficulty is the unknown filling grade of pipeworks of barge.

Status of pipeworks at start should be the same as at end:



Test 2.2: quantification of stripping/blended air in April 2009, needed for the aeration diagnostics

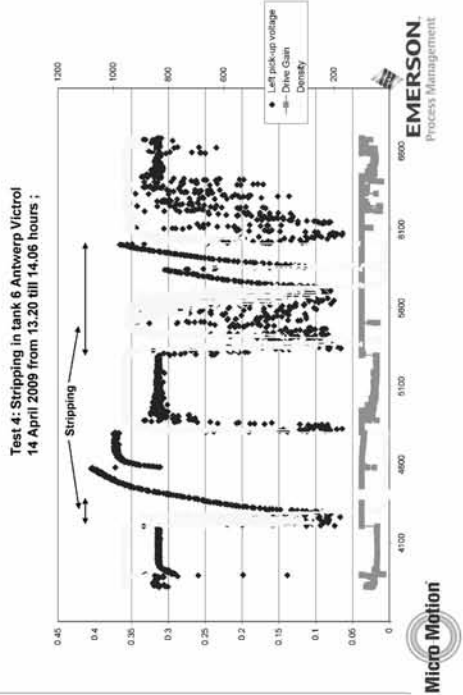

Test 2.2: quantification of stripping/blended air in April 2009, needed for the aeration diagnostics

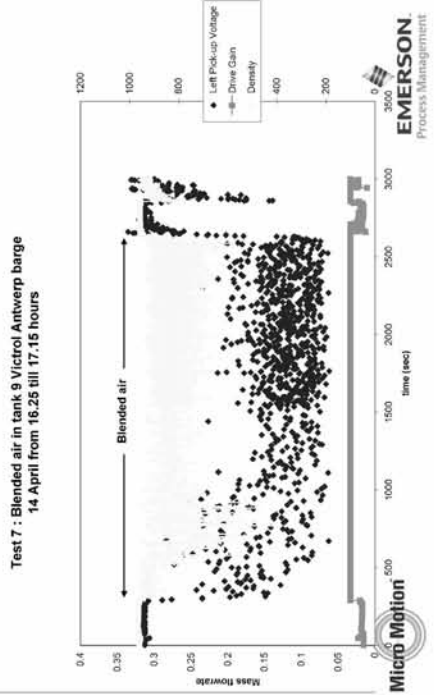

Test 2.2: quantification of stripping/blended air in April 2009, needed for the aeration diagnostics

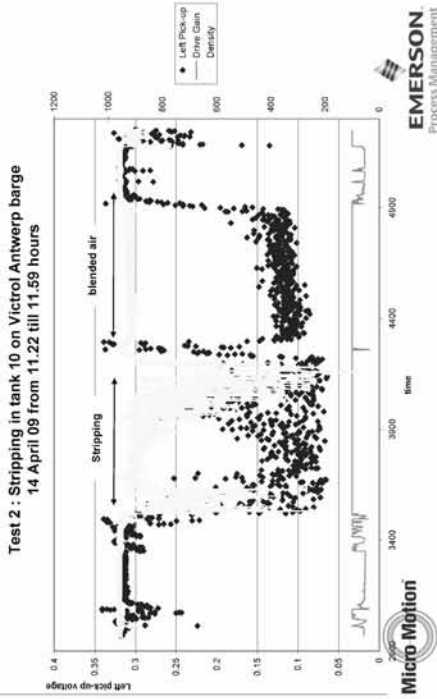

Test 2.2: quantification of stripping/blended air in April 2009, needed for the aeration diagnostics

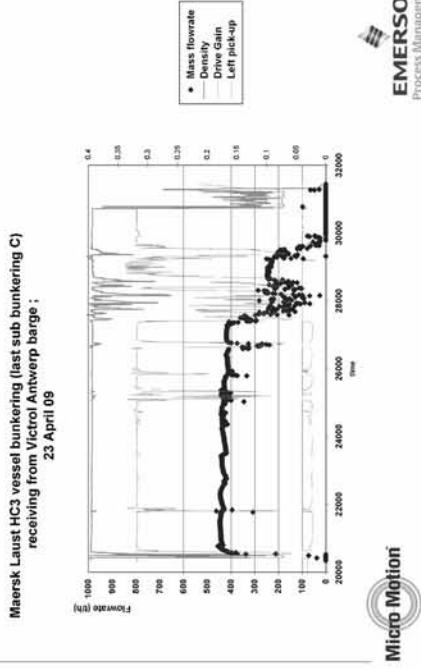

3. Bunker fuel tests

Test 3:
All 3 real bunkerings with HC3 meter on vessel <0.5%



3. Bunker fuel tests
Bunkerings in general

B-4: Victrol Antwerp typical bunkering on 9 Feb 2010 with HC3
930 ton LF380 high sulphure

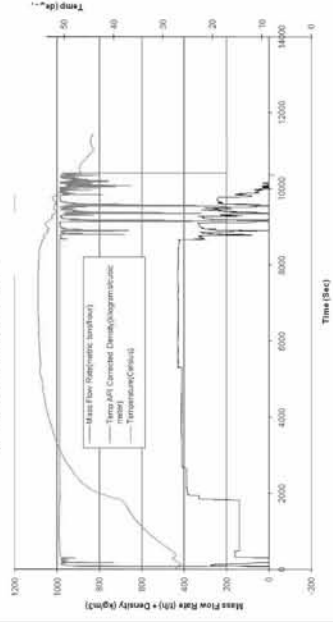

3. Bunker fuel tests Bunkerings in general

Aeration diagnostic tool gives:

“36.0 % of aeration limit”

total time	162,4	minutes
aerated time abs.	14,4	minutes
aerated time rel.	8,8	%
total mass	928,8	ton
aerated mass abs.	52,9	ton
aerated mass rel.	5,7	%



3. Bunker fuel tests Bunkerings in general

B.5: Victrol Antwerp (“ideal”) bunkering on 9 Feb 2010 with HC3
Pipework filled approx. same at stop as at start
1580 ton LF380 high sulphure

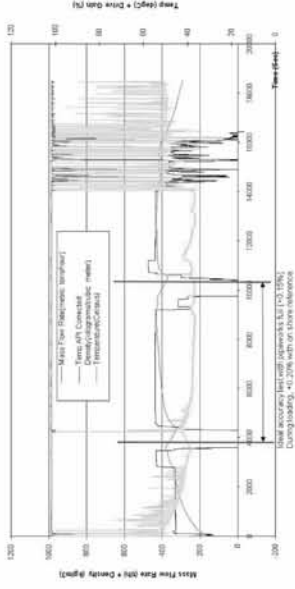

3. Bunker fuel tests Bunkerings in general

Aeration diagnostic tool gives:

“34.5 % of aeration limit”

total time	247,1	minutes
aerated time abs.	18,9	minutes
aerated time rel.	7,7	%
total mass	1579,0	ton
aerated mass abs.	85,4	ton
aerated mass rel.	5,4	%



Agenda

- 1 Scope of the bunker approval
- 2 Obtained approvals before starting with the bunker approval
- 3 Bunker fuel tests
- 4 Release of the bunker approval



4. Release of bunker approval

NMI has issued T10265 for bunkering applications:



EC type-examination certificate

Number **T10265** Revision 1
Project number: 9200777
Page 1 of 1

Issued by

NMI Certin B.V., designated and notified by the Netherlands to perform tasks with respect to conformity modules mentioned in article 3 of Directive 2004/22/EC, after having established that the measuring instrument meets the applicable requirements of Directive 2004/22/EC, to:

Manufacturer

Emerson Process Management Flow B.V.,
Neonstraat 1
6718 WX Ede
The Netherlands

Measuring instrument

A non-interruptible **measuring instrument** installed on a ship (barge and vessel), intended for the delivery/reception of bunker fuel.



4. Release of bunker approval

Characteristics of bunker approval T10265:

- HC3 sensor only
- Based on water calibration
- Flowrate (120 ~ 1200) t/h
- Temperature (30 ~ 70)°C
- Reynoldsnumber not lower than 400

Minimum flowrate (t/h) for bunker fuel applications per NMI T 10265 rev. 2

Viscosity at 50 °C cSt	Bunker fuel temperature									
	30 °C	35 °C	40 °C	45 °C	50 °C	55 °C	60 °C	65 °C	70 °C	70 °C
380	464	306	208	144	120	120	120	120	120	120
500	654	423	282	193	136	120	120	120	120	120
700	—	—	599	410	276	190	135	120	120	120
850	—	—	753	509	338	231	162	120	120	120



4. Release of bunker approval

Bunker Software: Ticket Print & Bunker Profile

MID Ticker Printer & ProLink II set-up:

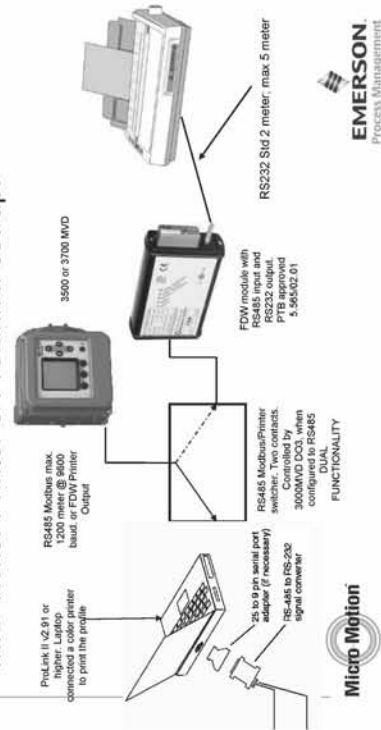

4. Release of bunker approval

Ticket Print approved incl. % Aeration Limit

Approved Measurements*
Micro Motion Inc, Div of Emerson
Herengroen Holland
7-00-9-00
M. RESET

SGL Number: 6

Reset Time

3-JUN-2010 14:27:07

Print Time

3-JUN-2010 14:27:07

Valve On Time

1-JAN-1996 0:00:00

Valve Off Time

3-JUN-2010 14:26:27

Mass Total

1.181 t

Aeration

0.0000 K

Overall OIM Block Pass

Accuracy within 0.5%

MID Center: T 10265

To convert mass to approx mass

in air, multiply by 0.998925

Approved Measurements*

IMPORTANT: Please check this

TEST to BDN Report

Original



Any Questions?



Technical explanation on Coriolis meters

APLFM conference
July 6 - 9, 2010
Singapore

by
Aart Pruysen
Approval Director Europe



Agenda the Coriolis meter

- 1 Coriolis force/Coriolis meter
- 2 Some characteristics for mass flow
 - Zero phenomena
 - Corrections
 - Low flow cut off
- 3 Water calibration = fluid cal
- 4 Mass performance in field
- 5 Density measurement
- 6 Density performance in field



Agenda the Coriolis meter

- 1 Coriolis force/Coriolis meter
- 2 Some characteristics for mass flow
Zero phenomena
Corrections
Low flow cut off
- 3 Water calibration = fluid cal
- 4 Mass performance in field
- 5 Density measurement
- 6 Density performance in field



Mass Flow Measurement: Men of Science



Sir Isaac Newton
1642-1727

Mathematician and physicist.
Described in 1686 three laws of motion in "Philosophiæ Naturalis Principia Mathematica".

Second Law of Motion states:

$$F = m \cdot a$$



Gustave Gaspard Coriolis
1792-1843

Engineer and mathematician.
Described in 1835 the Coriolis Effect in "Sur les equations du mouvement relatif des systemes de corps".

Coriolis acceleration is given by:

$$A_c = 2 \cdot \omega \cdot v$$



Mass Flow Measurement: Men of Science

- Newton's Second Law of Motion applies directly to a body (mass) moving in a stationary frame of reference
— Example: A ball rolling down a hill
- The inertial Coriolis force must also be included for a body (mass) moving in a rotating frame of reference
— Mass moves away from or toward the centre of rotation
— Force acts at right angles to the direction of motion
— Example: A ball moving on a rotating table



Coriolis Force

- As the mass moves toward a new position
 - It has constant radial velocity (V_{rad})
 - It has a changing tangential velocity (V_{tang})

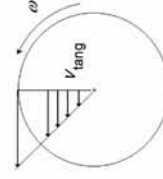
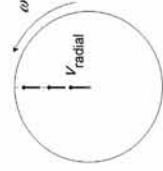

Coriolis Force

- The changing tangential velocity (V_{tang}) means there is an apparent

- Coriolis acceleration A_C
- Coriolis force F_C

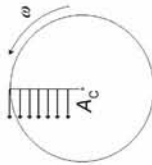

$$A_C = 2 \cdot \omega \cdot V_{\text{rad}}$$

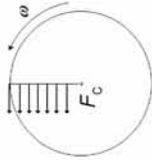

$$F_C = 2 \cdot \omega \cdot V_{\text{rad}}$$



Coriolis Force

Deflection relative to a rotating system: **Coriolis Force can not be delivered.** The path of the mass is deflected

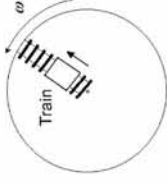
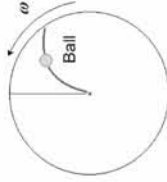

No deflection relative to rotating system: **Coriolis Force is delivered by tracks.** The Coriolis force is needed to let the train move straight.



Playground Video



Coriolis meter

- Analogy of rotating table and the Coriolis flow sensor
 - The rotating table is a vibrating tube
 - The ball is a particle of fluid mass
 - The radial velocity is the flow rate
 - The flow tube contains the mass and delivers the Coriolis acceleration to the mass
 - The mass reacts back on the tube with the Coriolis force causing the tube to twist



Coriolis meter

Flowing fluid mass particle δ_m in rotating tube:

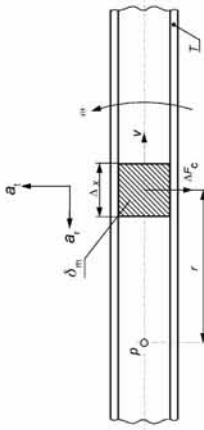

- a radial acceleration a_r (centripetal) equal to $\omega^2 r$ and directed towards p ;
- a transverse acceleration a_t (Coriolis) equal to $2 \omega v$ at right angles to a_r and in the direction shown



Coriolis meter

The Coriolis force is measured by means of the twist of a rotating tube.

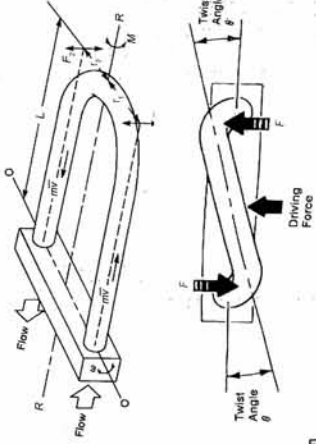

Coriolis meter

The Coriolis force is measured by means of the twist of a rotating tube.

$$Q_m = \frac{k\theta}{4\omega rL} \text{ Twist Angle } \theta$$

Mass flow proportional with twist θ .

How to measure the twist?

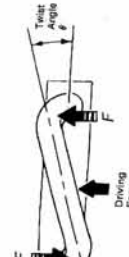

Coriolis meter

The mass flow rate is measured by means of difference in time (ΔT):

$$Q_m = \frac{k}{8r^2L} \Delta T_{\text{meas}}$$

Unique sensor factor ;

Flow Calibration Factor (FCF)

$$Q_m = \text{FCF} \cdot \Delta T_{\text{meas}}$$

Q_m independent of frequency of vibrating tubes

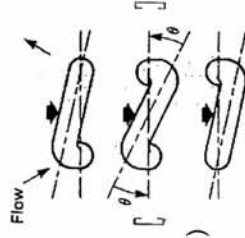

Flow Calibration Factor (as standardized with Micro Motion)

- The mass flow is calculated by multiplying the ΔT value by the unique **Flow Calibration Factor (FCF)** in g/s/ μ s
- Expressed as a number with 8 digits and two decimal points:
 - First 5 digits for the **flow sensitivity** (g/s/ μ s)
 - The other 3 digits are for the **Temperature Coefficient (TC)** for the sensor tube material (%/100°C).

Example: 4.27454.26

4.27454.26 : Flow sensitivity of the sensor
 4.2745**4.26** : Temperature Coefficient

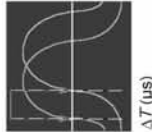

Flow Calibration Factor

- FCF is unique for each sensor
 - Determined during factory calibration
- FCF is found on the
 - Sensor Calibration Sheet
 - Sensor tagplate
- FCF is entered in the transmitter/core-processor
 - This is called configuration



Flow Calibration Factor (FCF)

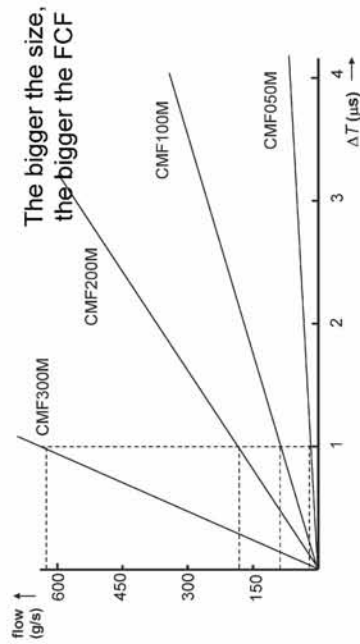

Flow Calibration Factor (FCF)

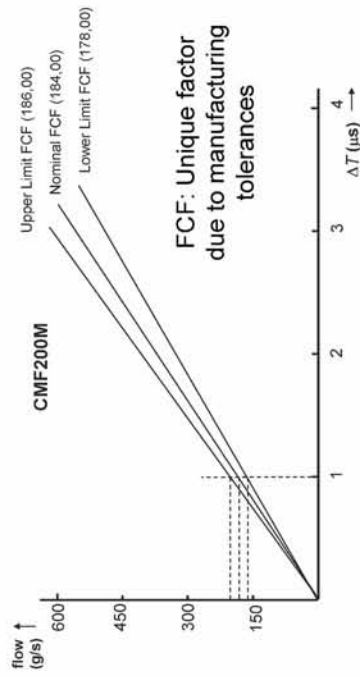

Coriolis sensor components Dual Tube Sensor

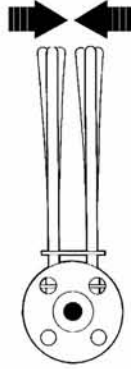
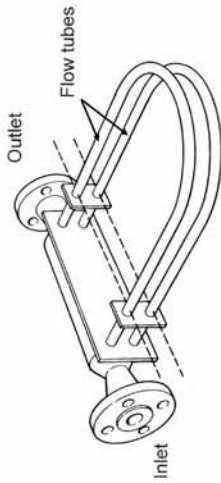

Micro Motion

EMERSON
Process Management

Coriolis sensor components Dual Tube Sensor

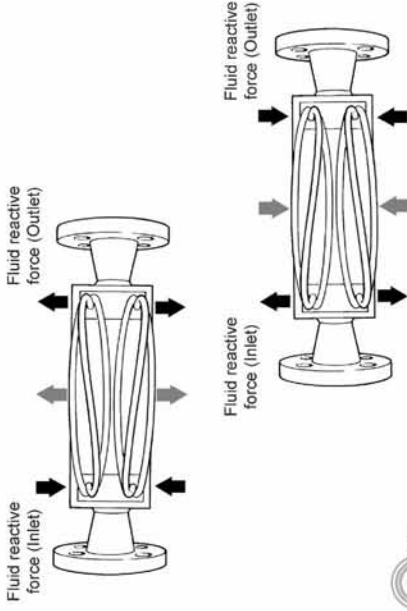

Micro Motion

Coriolis sensor Components (independent of size)

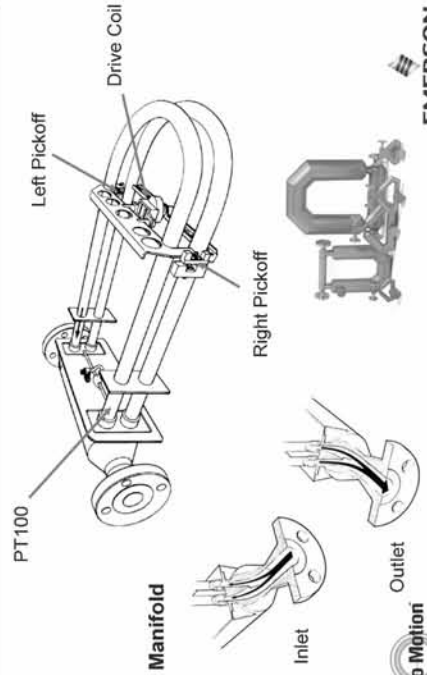

Micro Motion

EMERSON
Process Management

Dual Tube Design

- Advantages of dual tube design over single tube design
 - Lower sensitivity to external vibration
 - Two tubes are subjected to the same vibration
- Lower drive energy
 - Two tubes make a balanced mechanical system
- Higher sensitivity to mass flow
 - Two tubes provide double ΔT

Micro Motion

EMERSON
Process Management

Coriolis Sensor Geometries

- All Geometries are not created equal
- Design trade-offs are made for such things as:
 - Flow sensitivity & turnaround
 - Density accuracy
 - Fluid S.G. range (gas/liquid)
 - Materials of construction
 - Temperature effects
 - Drainability and Cleanability
 - Pressure limits



Coriolis Sensor Geometries

• Dual curved tube

- Highest sensitivity to flow
- Highest turnaround
- Highest density accuracy
- Best gas performance
- Best 2-phase performance, because of low frequency design
- Concentration measurement



■ Slightly curved dual tube

- Compact
- Provides drain ability
- Less turnaround & gas performance above category
- Lower density accuracy and not as good in measuring gases
- Higher tube frequency limits entrained air capability



■ Single straight tube

- To prevent plugging, provide drain ability & clean ability
- Limited accuracy and turnaround compared to dual curved tubes
- More prone to secondary effects than curved tube meters
- Not to be used with liquids with entrained gas



Coriolis sensor components

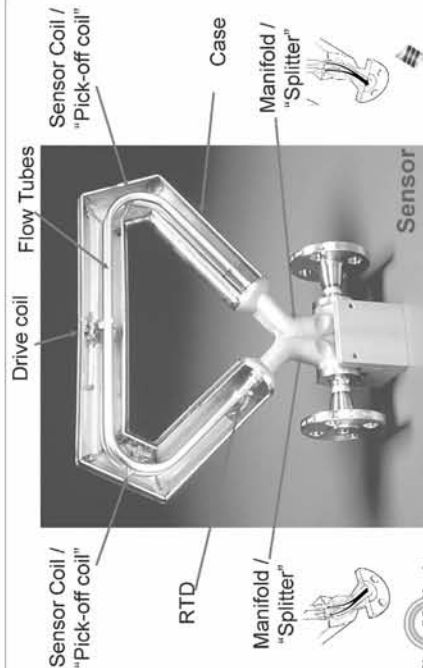

Coriolis meter components

The Coriolis flow meter consists of :

- sensor
- core-processor (Micro Motion specific)
- transmitter



Core-processor



Transmitter



Core Processor:

Contains all unique sensor parameters

Core Processor

- Integrally mounted to the sensor
- Digitally processes raw signals from sensor
 - Mass flow
 - Volume flow
 - Density
 - Temperature
 - Flow Totals

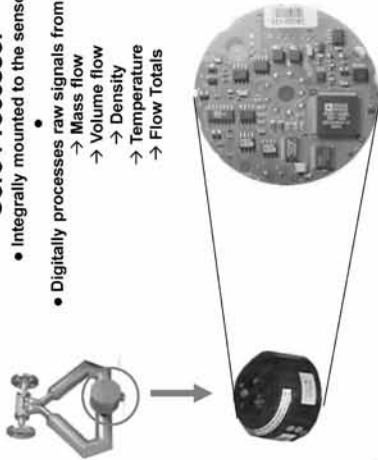

Sensor: Drive Coil

- A process fluid enters the sensor and is flowing in two tubes.
- The sensor flow tubes are energized and are oscillating at their natural frequency.

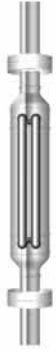

- The sensor flow tubes are vibrated in opposition to each other by energizing periodically a **drive coil**.



Sensor: Pickoff Coils

- Magnet and coil assemblies, called **pickoffs**, are mounted on the flow tubes.
- As each coil moves through the uniform magnetic field of the adjacent magnet, it creates a voltage in the form of a sine wave.

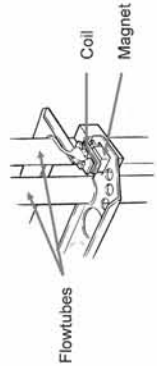
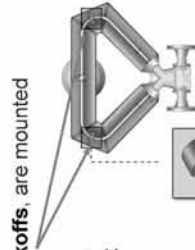
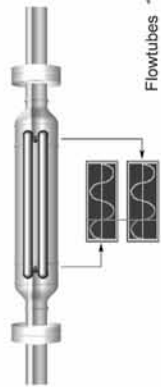

Mass Flow Measurement

- During a no flow condition, there is no Coriolis effect and the sine waves, induced by the Pickoffs, are in phase with each other.
- When fluid is moving through the flow tubes, the flow tubes are twisting in opposition to each other (Coriolis effect). The time difference between the sine waves (ΔT) is measured and is directly proportional to the mass flow rate.

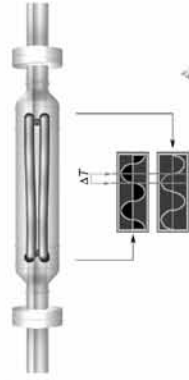
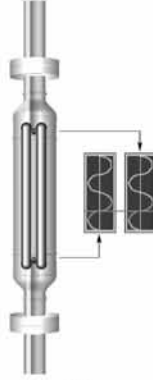

Sensor: PT100

- A PT100 temperature element is fixed on one of the tube's wall to measure the tubes temperature.

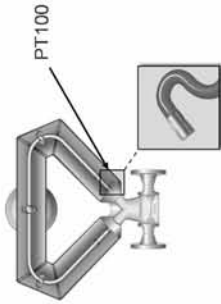

Mass Flow Processing

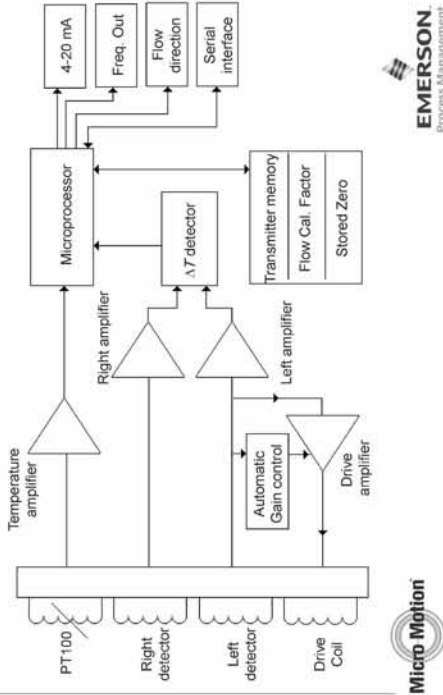

Agenda the Coriolis meter

- 1 Coriolis force/Coriolis meter
- 2 Some characteristics for mass flow
 - Zero phenomena
 - Corrections
 - Low flow cut off
- 3 Water calibration = fluid cal
- 4 Mass performance in field
- 5 Density measurement
- 6 Density performance in field



Zero phenomena

The Coriolis meter measures already a time difference when there is no flow due to manufacturing tolerances. Therefore software corrects for this offset.

After installation and during commissioning, this offset has to be stored in the electronics during NO FLOW condition and is called $\Delta T_{\text{zero-stored}}$.

Mass equation becomes now:

$$Q_m = FCF \times (\Delta T_{\text{meas}} - \Delta T_{\text{zero-stored}})$$



Zero phenomena

The measured time difference during operation is sum of time difference due to mass flow and time difference for no flow conditions $\rightarrow \Delta T_{\text{meas}} = \Delta T_{\text{massflow}} + \Delta T_{\text{zero-actual}}$

Performing auto zero procedure means under no flow conditions that:
 $\Delta T_{\text{meas}} = \Delta T_{\text{zero-actual}}$ and is stored as the new $\Delta T_{\text{zero-stored}}$



Zero phenomena

Mass flow calculation corresponds therefore with:

$$Q_m = FCF \times (\Delta T_{\text{massflow}} + \Delta T_{\text{zero-actual}} - \Delta T_{\text{zero-stored}})$$

If $\Delta T_{\text{zero-actual}}$ remains stable over time ($\Delta T_{\text{zero-actual}} = \Delta T_{\text{zero-stored}}$), the mass flow is calculated based only on $\Delta T_{\text{massflow}}$, which is correct.

If $\Delta T_{\text{zero-actual}}$ shifts over time ($\Delta T_{\text{zero-actual}} \neq \Delta T_{\text{zero-stored}}$), the mass flow is calculated with an absolute bias:

$$\Delta Q_m = FCF \times (\Delta T_{\text{zero-actual}} - \Delta T_{\text{zero-stored}})$$



Zero phenomena

The relative% error due to zero depends on actual flowrate and is bigger at lower flowrates:

$$\frac{\Delta Q_m}{Q_m} = \frac{FCF \times (\Delta T_{\text{zero-actual}} - \Delta T_{\text{zero-stored}})}{Q_m} \times 100\%$$



Influence of Temperature on Coriolis Twist

Effect of the temperature

- As the temperature of the flow tubes increases, the tubes get more flexible. This increase in flexibility results into a higher ΔT for the same mass flow rate.
- Without compensation the mass flow would read too much.
- The magnitude of the temperature effect not only depends on the tube temperature but also on the tube material and the tube geometry.
- Three wire Pt-100

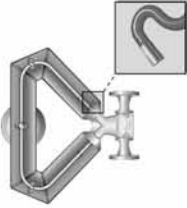

Factor is referred to as *FT*
 The tube temperature compensation for mass flow is usually expressed as a flow sensitivity change in % per 100°C temperature change.

Example: ΔT changes approx. 4.26% per 100°C
 316L Stainless Steel



Influence of Temperature on Coriolis Twist

Integral temperature correction in mass flow equation:

$$Q_m = \left(1 - \frac{FT}{10000} \times \text{Temp} \right) \times FCF \times (\Delta T_{\text{meas}} - \Delta T_{\text{stored zero}})$$

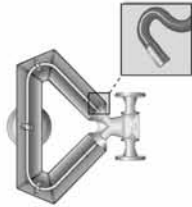

Example: ΔT changes approx. 4.26% per 100°C 316L Stainless Steel



Influence of Pressure on Coriolis Twist

Effect of the pressure

- As the pressure on the flow tubes increases, the tubes get less flexible. This decrease in flexibility results into a smaller ΔT for the same mass flow rate.
- The magnitude of the pressure effect not only depends on the tube pressure but also on the tube material and the tube geometry.
- Without compensation the mass flow would read too low (consult manufacturer's datasheet)
- Minor effect; in many cases negligible
- By external pressure transmitter (e.g. via HART protocol)

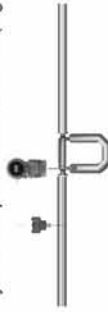

Factor is referred to as FP



Influence of Pressure on Coriolis Twist

Automatic pressure correction in mass flow equation by external pressure transmitter (depends on geometry):

$$Q_m = \left(1 - \frac{FT}{10000} \times \text{Temp} \right) \times [1 + FP(p_{\text{oper}} - p_{\text{cal}})] \times FCF \times (\Delta T_{\text{meas}} - \Delta T_{\text{stored zero}})$$

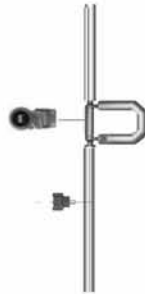

e.g. Micro Motion

% of rate per bar

liquid	% of rate per bar
CMF010	None
CMF025	None
CMF050	None
CMF100	-0.003
CMF200	-0.012
CMF300	-0.009
CMF400	-0.015



Influence of high viscosity liquid on Coriolis Twist

Correction for high viscosity liquids needed, depending on sensor geometry

Consult manufacturer for details: what sizes; systematic/random and magnitude

$$Q_m = \left(1 - \frac{FT}{10000} \times \text{Temp} \right) \times [1 + FP(p_{\text{oper}} - p_{\text{cal}})] \times FCF \times (\Delta T_{\text{meas}} - \Delta T_{\text{stored zero}}) \times VF$$



Final equation for mass

Equation in software of Micro Motion Coriolis meter :

$$Q_{m-Ind} = MF_m \times \left(1 - \frac{FT}{10000} \times Temp \right) \times [1 + FP(P_{oper} - P_{cal})] \times FCF \times (\Delta T_{rimms} - \Delta T_{stored zero}) \times VF$$

where

- $Q_{m-Indicated}$ (g/s)
- MF_m Meterfactor for mass (-)
- FCF Flow Cal Factor, unique for each sensor (g/s/μs)
- F temperature coefficient for mass flow, as configured in the Micro Motion electronics (% per 100 °C)
- T_{rimmo} temperature, as measured by micro Motion (°C)
- FP_{rimmo} pressure coefficient for mass flow, as configured in the Micro Motion (% per psi)
- P_{oper} pressure, as measured externally and connected to Micro Motion electronics via HART (psi)
- P_{cal} pressure at which the factors were determined during calibration (psi)
- $\Delta T_{measured}$ Measured time difference as determined by Micro Motion electronics (μs)
- $\Delta T_{zero-stored}$ Stored time difference in Micro Motion electronics for no flow conditions (μs)
- VF Viscosity Factor



Low flow cut off

To avoid an indication of mass flow when there is no flow, a cut off value was introduced.

No flow indication and no totalizing when measured flowrate is below the low flow cut off setting



Low flow cut off

Low flow cut off effect
(below Q_{low} , not totalizing)

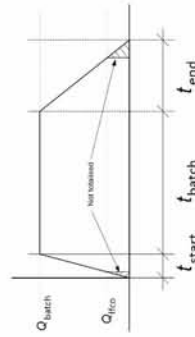

A systematic error may be introduced for short batches

$$\text{Rel error \% low flow cut off effect} = - \frac{Q_{low}^2}{Q_{batch}^2} \times \left[\frac{1}{1 + \frac{t_{batch}}{0.5 \times (t_{start} + t_{end})}} \right] \times 100\%$$

Example:

$$Q_{low} = 0.1 \times Q_{batch} ; t_{batch} = 60 \text{ sec} ; t_{start} = 2 \text{ sec} ; t_{end} = 4 \text{ sec}$$

$$\text{Effect \%} = -0.05\%$$



Agenda the Coriolis meter

- 1 Coriolis force/Coriolis meter
- 2 Some characteristics for mass flow
Zero phenomena
Corrections
Low flow cut off
- 3 Water calibration = fluid cal
- 4 Mass performance in field
- 5 Density measurement
- 6 Density performance in field



3. Water cal = fluid cal

Water calibration, as performed by the manufacturer by default, *may be representative* for all fluid applications between -10 and 50 Celcius



3. Water cal = fluid cal

The statement about transferability for Micro Motion is confirmed by NMI, the Weights and Measures authorization body in the Netherlands.



Nederlands Meetinstituut

C-SP-HW-360
blad 3 van 6

This procedure is possible because of the fact that tests have proven that the mass accuracy on water is representative for the mass accuracy on other liquids or gases which are mentioned in the official MID documents.
Representative for massflow:

- for liquid applications: no relevant deviations were observed between water and other liquids for which the meter is approved
- for gas application, the maximum deviation between water and gas was observed as 0.4%. In addition, a safety margin of 0.3% is introduced so that 0.7% is subtracted from the maximum permissible error for gas application (= 1% and 2%, depending on flowrate).



3. Water cal = fluid cal

“Water cal = fluid cal” differs per manufacturer
Applicable for Micro Motion:

- Flowfactor FCF is transferable (proven by a lot of testdata) ; confirmed by NMI, Dutch Weights and Measures authority
- Liquid applications: 0.20% (meets OIML R117 for pipe lines applications)
- Gas applications: 0.35%
- Additional uncertainties for high and low temperatures/pressures



Agenda the Coriolis meter

- 1 Coriolis force/Coriolis meter
- 2 Some characteristics for mass flow
Zero phenomena
Corrections
Low flow cut off
- 3 Water calibration = fluid cal
- 4 Mass performance in field
- 5 Density measurement
- 6 Density performance in field



4. Mass performance in the field

Apply ISO - GUM (Guide to the expression of Uncertainty in Measurement) and ISO 5168 for the uncertainty calculations:

INTERNATIONAL
STANDARD

ISO
5168

Second edition
2005-06-15

Measurement of fluid flow — Procedures
for the evaluation of uncertainties

Mesure de débit des fluides — Procédure pour le calcul de l'incertitude



4. Mass performance in the field

Equation in software of Micro Motion Coriolis meter :

$$Q_{m\text{-ind}} = MF_m \times \left(1 - \frac{FT \times \text{Temp}}{10000} \right) \times [1 + FP(P_{\text{oper}} - P_{\text{cal}})] \times FCF \times (\Delta T_{\text{mass}} - \Delta T_{\text{stored zero}}) \times VF$$

where :

- $Q_{m\text{-indicated}}$ - Indicated mass flowrate (g/s)
- MF_m - Meterfactor for mass (-)
- FCF - Flow Cal Factor, unique for each sensor (g/s/μs)
- FT_{rimo} - temperature coefficient for mass flow, as configured in the Micro Motion electronics (% per 100 °C)
- T_{rimo} - temperature, as measured by micro Motion (°C)
- FP_{rimo} - pressure coefficient for mass flow, as configured (% per psi)
- P_{oper} - pressure, as measured externally and connected to Micro Motion (psi)
- $P_{\text{stored-oper}}$ - pressure at which the factors were determined (psi)
- $\Delta T_{\text{measured}}$ - Measured time difference as determined by Micro Motion electronics (μs)
- $\Delta T_{\text{zero-stored}}$ - Stored time difference in Micro Motion electronics for no flow conditions (μs)
- VF - Viscosity Factor

4. Mass performance in the field

Uncertainty analysis, based on not correcting for water errors
Micro Motion sensors CMF 025; 050 ; 100 ; 200 ; 300

TYPICAL LIQUID APPLICATION

Assumptions:

- rangeability 10:1, compared to nominal flow
- zero effect during water calibration : 50 % of zero-specification
- zero effect during service : 100 % of zero-specification
- liquid temperature difference between water calibration and in situ: 15 Celcius
- pressure difference between water calibration and in situ : 10 bar



Mass performance in the field; Example Micro Motion

Water calibration	Uncertainty in FCF out of water calibration	Uncertainty in mass at 100%	Uncertainty in mass at 10%
Field	Zero effect during operation	0.005%	0.050%
	Type A in single measurement (repeatability)	0.020%	0.040%
	Other product/ other installation	0.040%	0.040%
	MMI temp. measurement shift (0.4 Celcius)	0.017%	0.017%
	MMI temp coefficient (0.1% per 100°C; delta T = 15 Celcius)	0.015%	0.015%
	Pressure measurement (0.1 bar)	0.001%	0.001%
	MMI pressure coefficient (1/20 of non. ; delta P= 10 bar)	0.008%	0.008%
	Long term stability if material compatibility is assured	0.015%	0.015%
	Uncertainty of mass meter in the field	0.127%	0.141%



Mass performance in the field; Example Micro Motion

Subsequent/periodic verification:

Only verifying the zero is sufficient to be within field performance specification in case material compatibility is assured.

If not sure, an additional verification on density gives a extra assessment for field performance on mass flow (see further).



Agenda the Coriolis meter

- 1 Coriolis force/Coriolis meter
- 2 Some characteristics for mass flow
Zero phenomena
Corrections
Low flow cut off
- 3 Water calibration = fluid cal
- 4 Mass performance in field
- 5 Density measurement
- 6 Density performance in field



5. Density Measurement

- Density measurement is based on the natural frequency of the system including the flow tubes and the process fluid.
 - As the mass *increases*, the natural frequency of the system *decreases*.
 - As the mass *decreases*, the natural frequency of the system *increases*.



5. Density Measurement

- The density of the process fluid can be derived from the frequency of oscillation of the sensor. This frequency signal is taken from the **pickoff coils**.



$$\text{DriveFrequency} = \frac{1}{2\pi} \sqrt{\frac{\text{tube stiffness}}{M_{\text{tube}} + M_{\text{fluid}}}}$$

- The volume of the fluid contained in the flow tubes remains constant, so the only way mass can change is if density changes. Because of this relationship between mass and density, the natural frequency of the flow tubes indicates also the density.

$$\text{DriveFrequency} = \frac{1}{2\pi} \sqrt{\frac{\text{tube stiffness}}{M_{\text{tube}} + \rho V}}$$



5. Density Measurement

$$f = \frac{1}{2\pi} \sqrt{\frac{\text{tube stiffness}}{M_{\text{tube}} + \rho V}} \Rightarrow$$

$$T = \frac{1}{f} \Rightarrow 4\pi^2 f^2 = \frac{k}{M_{\text{tube}} + \rho V} = \frac{4\pi^2}{T^2}$$

$$\Rightarrow \rho = \frac{k}{4\pi^2 V} \cdot \frac{M_{\text{tube}}}{V}$$

$$\Rightarrow \rho = C_1 \cdot T^2 - C_2$$

Micro Motion $C_2 \approx 2500 \text{ kg/m}^3$

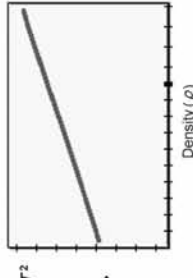
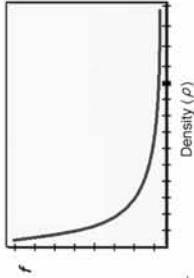

5. Density Measurement

- Two products with a known density are necessary for the density calibration.

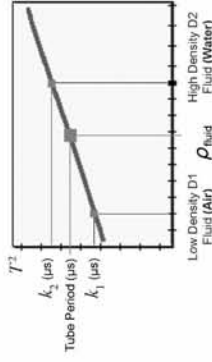

$$\rho_{\text{fluid}} = \frac{T^2 - k_1^2}{k_2^2 - k_1^2} (D_2 - D_1) + D_1$$

Micro Motion

EMERSON
Process Management

Influence of Temperature on Tube Period T

Effect of the temperature

- As the temperature of the flow tubes increases, the tubes get more flexible. This increase in flexibility results into a lower tubes frequency for the same density.
- Without compensation the density would read too much.
- The magnitude of the temperature effect not only depends on the tube temperature but also on the tube material and the tube geometry.
- Three wire Pt-100

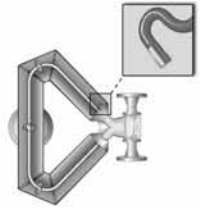

Factor is referred to as DT

Example: for the same density the square of the measured periodic time changes 4.45% per 100°C for a 316 L Stainless Steel CMF200 sensor

Micro Motion

EMERSON
Process Management

Influence of Temperature on Tube Period T

Temperature correction in density equation:

$$\rho_{\text{fluid}} = \frac{\left(1 - \frac{DT}{10000} \times \text{Temp}\right) \times T^2 - k_1^2}{k_2^2 - k_1^2} (D_2 - D_1) + D_1$$

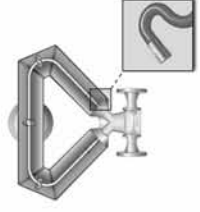

Micro Motion

EMERSON
Process Management

Influence of Pressure on Tube Period T

Pressure correction in density equation (depending on geometry):

$$\rho_{\text{fluid}} = \frac{\left(1 - \frac{DT}{10000} \times \text{Temp}\right) \times T^2 - k_1^2}{k_2^2 - k_1^2} (D_2 - D_1) + D_1 + DP \times (P_{\text{oper}} - P_{\text{cal}})$$

Factor is referred to as **DP**



e.g. Micro Motion

kg/m³ per bar

CMF010	None
CMF025	0.058
CMF050	-0.029
CMF100	-0.087
CMF200	0.0145
CMF300	0.0029
CMF400	-0.145



Influence of flow effect

A positive density error will occur with increasing flowrate (negative correction needed)

$$\rho_{\text{fluid}} = \frac{\left(1 - \frac{DT}{10000} \times \text{Temp}\right) \times T^2 - k_1^2}{k_2^2 - k_1^2} (D_2 - D_1) + D_1 + DP \times (P_{\text{oper}} - P_{\text{cal}}) - FD \times \Delta T^2$$

Final equation



Density Calibration Factors

- Each sensor has Density Calibration Factors
 - Factors depend on the transmitter type
 - Density sensitivity of the sensor
 - Relationship between density and Tube Period T
 - Temperature Coefficient Factor of the sensor
 - Temperature sensitivity of the sensor tubes

- DCF is unique for each sensor
 - Determined during factory calibration
- DCF is found on the
 - Sensor Calibration Sheet
 - Sensor tagplate
- DCF is entered in the transmitter
 - This is called configuration

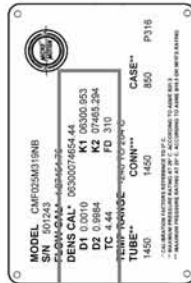

Density Calibration Factors



- D_1 = Actual density of air at air calibration
- D_2 = Actual density of water at water calibration
- k_1 = Tube Period air corrected to 0°C
- k_2 = Tube Period water corrected to 0°C
- TC = Temperature correction factor (%/100°C)
- FD = Effect of Flow on measured Density



Density Processing

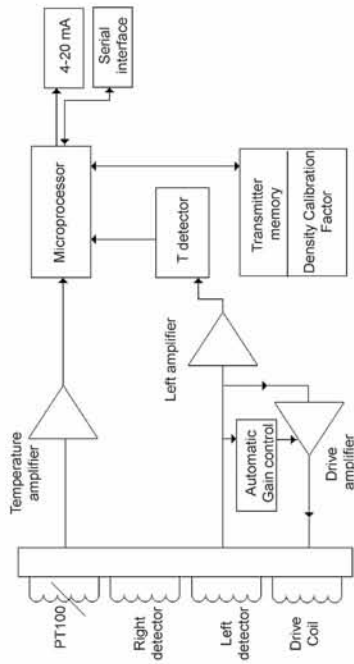

EMERSON
Process Management

EMERSON
Process Management

Agenda the Coriolis meter

- 1 Coriolis force/Coriolis meter
- 2 Some characteristics for mass flow
Zero phenomena
Corrections
Low flow cut off
- 3 Water calibration = fluid cal
- 4 Mass performance in field
- 5 Density measurement
- 6 Density performance in field

6. Density performance in the field

Uncertainty analysis, based on not correcting for water errors
Micro Motion sensors CMF 025; 050 ; 100 ; 200 ; 300
TYPICAL LIQUID APPLICATION

Assumptions:

- liquid temperature difference between water calibration and in situ : 15 Celcius
- pressure difference between water calibration and in situ : 10 bar



EMERSON
Process Management

Density performance in the field; Example Micro Motion

Uncertainty, density out of water calibration (0.1% per 100 °C; data n = 20 Cobles)	CMF 025 ; 050 ; 100 ; 200 and 300 kg/m ³
NMI temp coefficient	0.975
First density calibration	0.925
Second density calibration	0.020
Temperature during first density calibration (0.5C)	0.095
Temperature during second density calibration (0.6C)	0.145
Temperature shift during operation (0.4C)	0.011
Pressure measurement (0.1 bar)	0.950
NMI pressure coefficient (1/20 of nom. ; data n = 10 bar)	0.009
Time measurement during calibration	0.044
Time measurement during calibration	0.066
Long term stability as case material compability is granted (stiffness 0.015%)	0.066
Uncertainty of density in the field	0.900
	0.94

Density performance in the field; Example Micro Motion

Subsequent/periodic verification:

A shift in stiffness C_1 (e.g. erosion/corrosion) gives directly a big shift in density.

$$\rho = C_1 \cdot T^2 - C_2$$

$$C_2 \approx 2500 \text{ kg/m}^3 \longrightarrow C_1 = 3300 \text{ kg/m}^3$$

A shift in stiffness C_1 of 0.05% gives a shift of 1.65 kg/m³ in density but only a shift of 0.05% in mass flow.

A shift in C_2 (e.g. coating) does not effect mass flow



Density performance in the field; Example Micro Motion

Conclusion:

If density is within spec, then definitely the mass flow is also within spec.

It is justified to perform a verification on zero flow and density to omit field calibration

Only if criteria for density is exceeded, then a flow calibration is needed (field or lab)



Also volume flowrate and totalizes

$$\text{Volume Flow Rate} = \frac{\text{Mass Flow Rate}}{\text{Density}}$$

- Flow totals are calculated by integrating the flow rate over time.

$$\text{---Mass Total} = \int \text{Mass flow rate} \cdot dt$$

$$\text{---Volume Total} = \int \text{Volume flow rate} \cdot dt$$



Summary

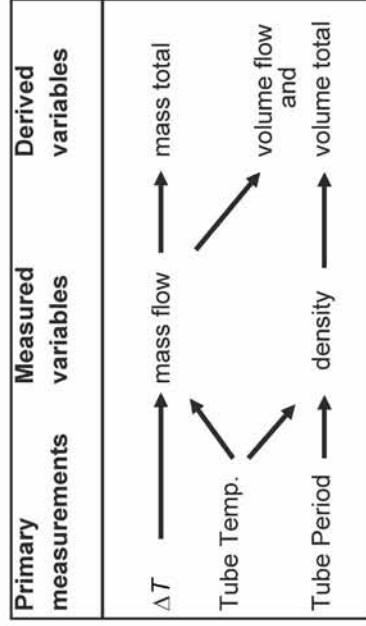

Any Questions?



Overview of the Legal Metrology System on mass flow meter in China

Speaker: Gong Lei

From: ChongQing Academy of Metrology and Quality Inspection
P.R. China

Overview of the Legal Metrology System on mass flow meter in China

1: Mass flow meter in China

1.1: Background introduction of mass flow meter

The saleroom of Mass flow meter is increasing with the rate of 50% per year and keep the primary market in high precision flow meters.

It's estimated that Mass flow meter will keep 40%~50% market in high precision flow meters with 10~12 hundreds million dollars global saleroom in 2010.

Overview of the Legal Metrology System on mass flow meter in China

1	Mass flow meter in China
2	Verification of mass flow meter in China
3	Legal Metrology System on mass flow meter in China

Overview of the Legal Metrology System on mass flow meter in China

1: Mass flow meter in China

1.2: Introduction of mass flow meter

1.2.1 Principle and Category

Mass flow meter is used to measure the mass flow rate or total mass quantity through specify section .

There are Coriolis mass flow meter, thermal mass flow meter, impact mass flow meter and other type mass flow meters distinguished by Principle.

Mass flow meter are also divided into direct mass flow meter and indirect mass flow meter by composing .

Overview of the Legal Metrology System on mass flow meter in China

1: Mass flow meter in China

1.2.2 Mass flow meter in China

Currently, Coriolis mass flow meter developed quickly in China. With the manufacture technology advanced, China issue the verification regulation especially for Coriolis mass flow meter—JJG 1038—2008 《Coriolis mass flow meters》.

There are other mass flow meters widely used in China, which must be verified according to verification regulation JJG 897—1995 《mass flow meters》.

Overview of the Legal Metrology System on mass flow meter in China

1: Mass flow meter in China

1.2.3 Type distributing in China

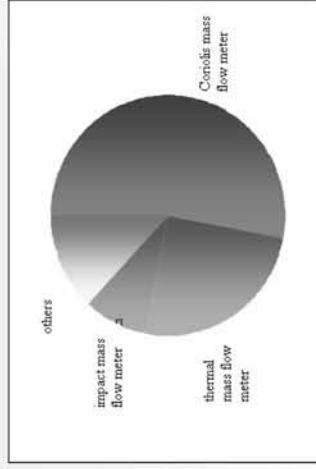

Overview of the Legal Metrology System on mass flow meter in China

1: Mass flow meter in China

1.2.4 Applying field in China

- (1) Petrochemical
- (2) Chemical
- (3) Foodstuff
- (4) Medication

Overview of the Legal Metrology System on mass flow meter in China

1: Mass flow meter in China

1.2.4 Applying field in China

- (5) Paper making
- (6) Spinnery, dyeing
- (7) Energy sources, transfers
- (8) Environmental protection industry

Overview of the Legal Metrology System on mass flow meter in China

1: Mass flow meter in China



1.2.4 Apply field distributing in China

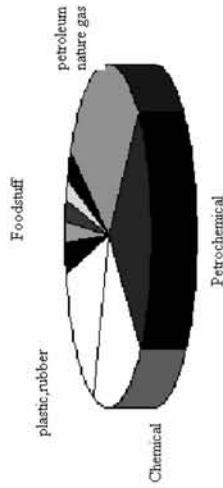

Overview of the Legal Metrology System on mass flow meter in China

1: Mass flow meter in China



1.3: Mass flow meter manufactory in China

Previously, mass flow meters used in China are mostly imported. Usually from : Micro Motion , Endress+Hauser , Rheonik, ABB, KROHNE, Danfoss, etc.

At present, many China company have the ability to manufacture mass flow meter, there are: Taiyuan aerial instrument corporation, Dalian Zhonglong instrument corporation , Shanghai Yiluo instrument corporation , etc.

Overview of the Legal Metrology System on mass flow meter in China

1: Mass flow meter in China



2.5 Mass flow meter requirement region in China

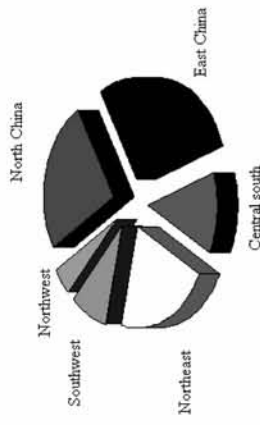

Overview of the Legal Metrology System on mass flow meter in China

1: Mass flow meter in China



1.3 Mass flow meter manufactory distributing in China

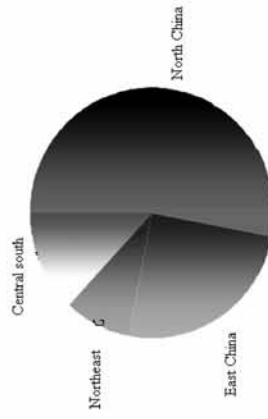

Overview of the Legal Metrology System on mass flow meter in China



2: Verification of mass flow meter in China

2.1: Verification of mass flow meter in China

Verification of mass flow meter in China must according to the Verification regulation JJG 1038—2008 《Coriolis mass flow meters》 or JJG 897—1995 《mass flow meters》 correspondingly.

Coriolis mass flow meter:

Priority-use mass method standard facility , also can use volume method standard facility or master meter method standard facility .The standard facility uncertainty must less than the 1/3 of the MPE of meter. Verification must include these flow rate:

$$q_{\max} , 0.5 q_{\max} , 0.2 q_{\max} , q_{\min} , q_{\max}$$

Overview of the Legal Metrology System on mass flow meter in China



2: Verification of mass flow meter in China

2.2: Verification of mass flow meter in China

Thermal mass flow meter:

Use soap film gas standard facility, Bell prover gas standard facility , PV/Tt gas standard facility , master meter gas standard facility. The standard facility uncertainty must less than the 1/3 of the MPE of meter. Verification must include these flow rates:

$$q_{\max} , 0.5 q_{\max} , 0.2 q_{\max} , q_{\max}$$

if $q_{\max} / q_{\min} > 5$, then q_{\min} must included.

Overview of the Legal Metrology System on mass flow meter in China



2: Verification of mass flow meter in China

2.3: Verification of mass flow meter in China

Impact mass flow meter:

Use balance and weight when verify In-situ. The standard facility uncertainty must less than the 1/3 of the MPE of meter. Usually choose the common flow rate and persist at least 60 seconds.

Overview of the Legal Metrology System on mass flow meter in China



3: Legal Metrology System on mass flow meter in China

3.1: Legal Metrology Manage in China

According to the **Metrology law** of China, Public Metrology standard, highest Metrology standard of each department and meters used for trade, security protection , medical treatment and healthy, environment inspect are required to verify forcedly, meters used for other area can choose to verify or calibrate by user self.

Overview of the Legal Metrology System on mass flow meter in China



3: Legal Metrology System on mass flow meter in China

3.2: Where and How to verify or calibrate

According to the **Metrology law** of China, verification or calibration must carry out by there institutions which are specified or accredited by government Metrology department of county or up grade. Verification must at these institutions and must carry out ever specified cycle.

Verification must according to the verification regulation JJG 1038—2008 《Coriolis mass flow meters》 / JJG 897—1995 《mass flow meters》.

Overview of the Legal Metrology System on mass flow meter in China



3: Legal Metrology System on mass flow meter in China

3.3: Verification cycle of mass flow meter in China

Coriolis mass flow meter:

Precision better than 0.5 class usually no long than one year;

others usually no long than two years.

Other mass flow meter:

Used for trade metrological no long than one year;

others usually no long than two years.

Overview of the Legal Metrology System on mass flow meter in China



The End

Thank you for your attention!

Overview of the Legal Metrology System on mass flow meter in China



100% INDONESIA

Overview of the Legal Metrology System on Mass Flow Meter in Indonesia

By:
Henry Gunawan

**DIRECTORATE OF METROLOGY
MINISTRY OF TRADE**

Self introduction

Name: Henry Gunawan
 E-mail: goen133@yahoo.com
 Position: Sub-Directorate of Measurement Standard and Metrology Laboratory, Directorate of Metrology, Ministry of Trade

Task: To prepare the regulation and policy concerning the measurement standard of legal metrology

Organization Scheme

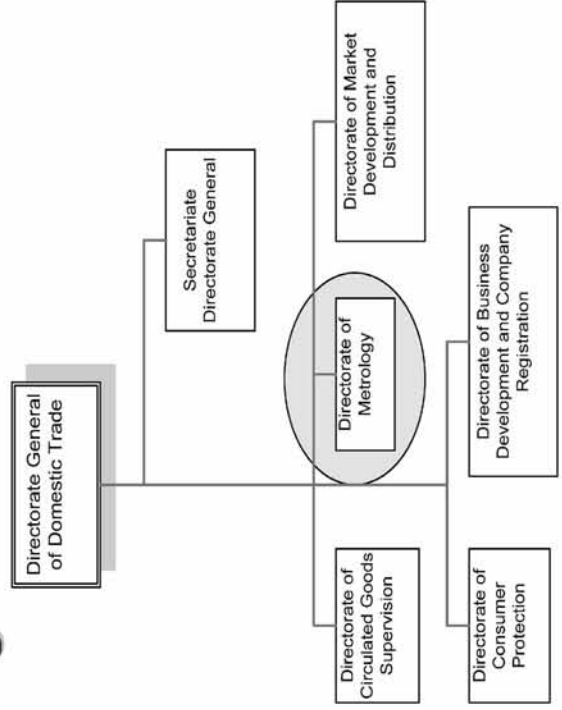

Directorate of Metrology

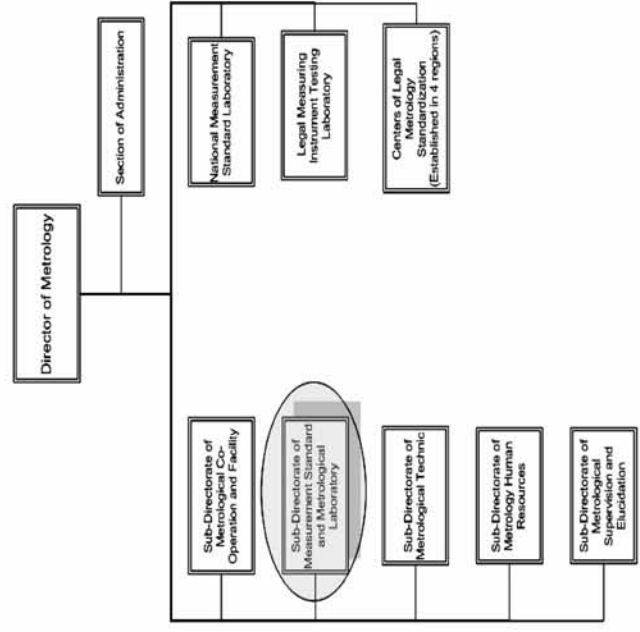

LEGAL METROLOGY SYSTEM IN INDONESIA

- In general, legal metrology system in Indonesia consists of legal control of measuring instruments, legal control of pre-packaged goods, and metrological supervision.
- Directorate of Metrology is a public institution under Ministry of Trade, having responsibility to manage legal metrology activities, especially related with trade in Indonesia.
- Since 2004, the legal metrology system in Indonesia is transformed from centralized to decentralized authority, i.e. regional autonomy. Metrological activities, e.g. supervision, verification/re-verification is conducted by 54 regional verification offices.

Related Regulations on Legal Control of Measuring Instruments

- ☐ Law No. 2 Year 1981 on Legal Metrology
- ☐ Government Regulation No. 2 year 1985 on General Requirements of Legal Measuring Instruments
- ☐ Ministerial Decree:
 - No.637 year 2004 on Imported Measuring Instruments
 - No. 638 year 2004 on Measuring Instruments requiring Special Treatments
 - No.08 year 2010 on Measuring Instruments Requiring Verification/Re-verification

Legal Metrology System for Mass Flow Meter

Ministerial Decree No.637 year 2004 on Imported Measuring Instruments

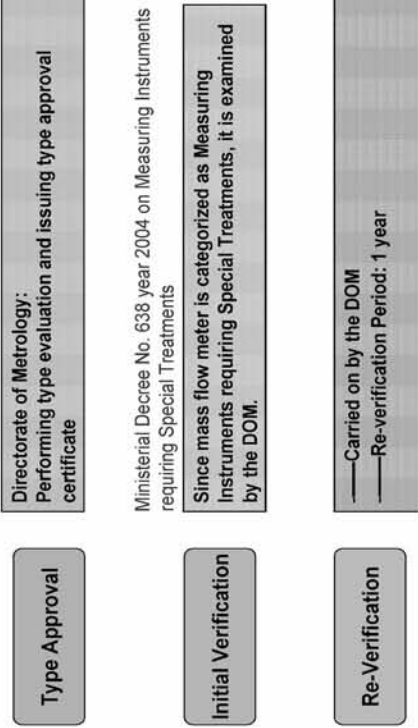

The use of mass flow meter

- It is used mainly in the transaction of fuel products, e.g. petroleum. Together with other legal measuring instruments, mass flow meters constitute important role in Indonesia's economy.
- Some instruments are required in the transaction between sellers and consumers: fuel dispenser, gas dispenser, prepackaged LPG.
 - Others are required in the transaction between sellers: fuel master meter, volumetric gas meter, mass flow meter

Legally controlled measuring instruments

Ministerial Decree No.08 year 2010 on Measuring Instruments Requiring Verification/Re-verification:

- 8.....
9. Moisture Meter
10. Dynamic fluid measuring instruments:
- a. Fuel meter:
- 1) Volumetric-flow meter;
 - 2) Turbine flow meter;
 - 3) Direct Mass Flow Meter.
- b. Water meter:
- 1) Cold water meter;
 - 2) Hot water meter.
- c. Meter Prover;
- d. Ultrasonic Liquid Flow Meter.
11. Gas Measuring Instruments:

Related Data on Fuel Meter

Number of type approval application (year 2006~2009):

Fuel dispenser	396
Fuel flow meter	40
Working fuel flow meter	83
Mass flow meter	12
Others	108
Total	639

Complete Application: 24
(mass flow meter : 2, it is being examined in 2009)

DATA OF LEGAL MEASURING INSTRUMENT VERIFICATION

No.	Year	Verification	Re-verification
1	2003	3,445,641	1,929,140
2	2004	2,445,233	1,312,892
3	2005	3,384,618	3,784,091
4	2006	3,589,007	3,945,611
5	2007	3,853,186	4,173,668
6	2008	3,761,011	2,382,400
7	2009	2,736,093	2,244,924

Data of flow meter and mass flow Verification (V) / re- verification (R) 2007-2009

Instruments	2007		2008		2009	
	V	R	V	R	V	R
Flow Meter	37	837	0	1930	31	885
Mass Flow	6	28	82	60	1	41

Problems in Legal Metrology System

General:

- metrology supervision is not optimal yet → affects the compliance of verification/re-verification
- Both central and regional capacity of measuring instruments verification is not sufficient
- Third party involvement in verification/re-verification is not regulated yet

Specific problems on Mass Flow Meters:

- Technical requirements for mass flow meter not available yet. The formal adoption of International Recommendations is required → not all legal measuring instruments provided with respective technical requirements
- Lack of facility and personnel to carry out mass flow meter testing → some testing are carried out with limited equipment and method

THANK YOU



SIRIM BERHAD
MALAYSIA : Economy Report



Mass Flow Meters in Malaysia

By Mohd Noor b. Mohd Ghafar
National Metrology Laboratory - SIRIM Berhad
MALAYSIA



SIRIM BERHAD
Organization Profile

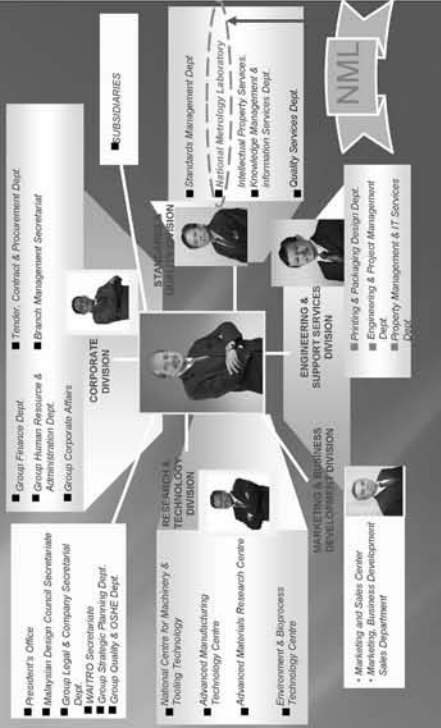

- President's Office
- Malaysian Design Council Secretariat
- Group Legal & Company Secretarial Dept.
- IAWITRO Secretariate
- Group Strategic Planning Dept.
- Group Quality & OQIE Dept.
- Group Finance Dept.
- Group Human Resource & Administration Dept.
- Group Corporate Affairs
- Branch Management Secretariat
- Branch Management Dept.
- Group Corporate Affairs
- RESEARCH & TECHNOLOGY DIVISION
 - National Centre for Machinery & Tooling Technology
 - Advanced Manufacturing Technology Centre
 - Advanced Materials Research Centre
 - Environment & Bioprocess Technology Centre
- MARKETING & BUSINESS DEVELOPMENT DIVISION
 - Marketing and Sales Center
 - Customer and Management Sales Department
- ENGINEERING & SUPPORT SERVICES DIVISION
 - Printing & Packaging Design Dept.
 - Manufacturing & Project Management Dept.
 - Property Management & IT Services Dept.
- STANDARDS DIVISION
 - Standards Management Dept.
 - National Metrology Laboratory
 - National Priority Services: Knowledge Management & Information Services Dept.
 - Quality Services Dept.
- SUBSIDIARIES

NML



NML – SIRIM BERHAD

Department Profile

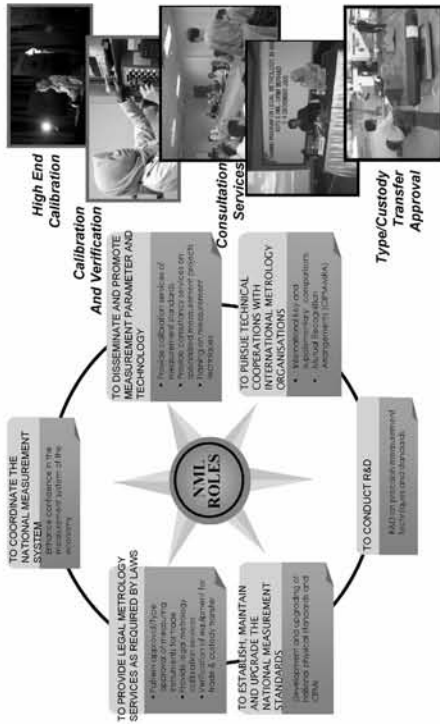

NML – SIRIM BERHAD

Department Profile

NATIONAL METROLOGY LABORATORY

NML - A Brief History

- Began with the establishment of the Metrology Unit under the Standards and Industrial Research Institute of Malaysia (SIRIM) in 1975.
- In 1979, SIRIM was appointed as the Custodian of Weights & Measures by the Ministry of Trade and Industry under the Weights and Measures Acts 1972.
- In 1993, it was delegated the responsibility to maintain the Malaysian Standard Time following the appointment of SIRIM as the National Time Keeper.
- In 1996, SIRIM was corporatized into a government wholly owned company known as SIRIM Berhad.



NATIONAL METROLOGY LABORATORY

Department Profile

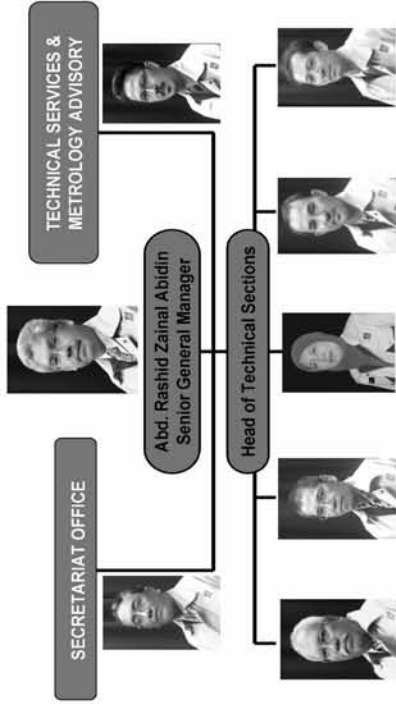

NATIONAL METROLOGY LABORATORY

Department Profile

Implementation Of A Laboratory Quality Management System

As part of the global MRA requirements for the NMIs, NML is planning to seek accreditation for its quality and management system in accordance with ISO/IEC 17025. Documentation of the quality system manual and quality procedures have been completed.

Regional & International Metrology Membership

The NML participates in the activities of the following organizations for which Malaysia is a member of:

- APMP —since 1977
- OIML —since 1989 (corresponding Member)
- APLMF —since 1994
- Metre Convention —since 3 Sept 2001 (full member)



NML – SIRIM BERHAD

Background & Professional Experience

- Graduated from University of Technology Mara in 2003
- Holder of Bachelor Degree in Electrical Instruments Engineering
- Sept 1999 ~ Dec 2000 : Work as Engineer at Samsung Malaysia
- Mac '03 ~ Apr '04 : Work as Engineer at DSC Engineering Sdn. Bhd.
- May '04 ~ present : Work as Metrologist at National Metrology Laboratory – SIRIM
- Currently in charge of Water Flow Laboratory and Volume Laboratory, Flow Metrology Section
- Involve in :
 - Scientific Metrology : Maintaining the standards in the lab – Platform Balance, Prover Tank, Std. Measure Tank, Water Meter and etc.
 - Industrial Metrology : Calibration of water flow meter – Water Meter, Rota Mass Flow Meter, etc.
 - Legal Metrology : Pattern Approval of Flow Meter, Water Meter, Fuel Dispenser, Water Dispenser, Custody Transfer Verification & Calibration Activities.



NML – SIRIM BERHAD

Mass Flow Meters in Malaysia

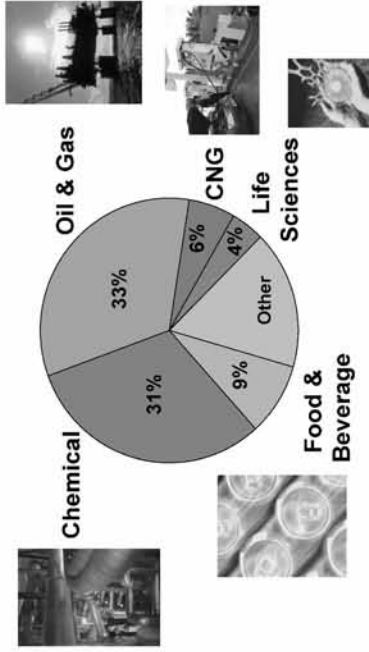

NML – SIRIM BERHAD

Mass Flow Meters in Malaysia

Mass flow meters used in Malaysia :

- Oil & Gas
 - offshore e.g: platform processing plant (Platform Petronas, Exxonmobil, Shell and etc.)
 - onshore e.g: processing plant, refinery plant (PGB, PPMSB, PML, CUF and etc.)
- Chemical
 - manufacturing factory, testing & calibration lab and research lab
- Food & Beverage
 - manufacturing food factory (KFC), MPOB.
- CNG (Compressed Natural Gas)
 - transportations (taxies, busses and private users)



NML – SIRIM BERHAD

Legal Metrology System in Malaysia

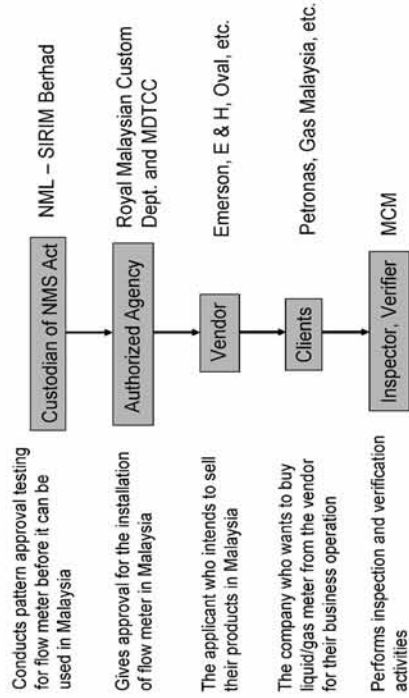

NML – SIRIM BERHAD

Current Situation in Malaysia



- In Malaysia, the Mass Flow Meter can be divided into 2 categories :
- i) Custody Transfer Meter (CTM) i.e : Oil & Gas industry and CNG
- ii) Non- Custody Transfer Meter (NCTM) i.e : Chemical, Food & Beverage, Life Science and others.
- For CTM, the approval of a brand new CTM is much more easier to be done with the assistance from the client (Petronas, Shell, Exxon-Mobil) where they require for any flow meter installed in their compound must get pattern approval from NML - SIRIM Berhad.
- The re-verification of CTM is done based on verification schedule planned by the client (once a year, etc.)and attended by MCM or NML-SIRIM Berhad.
- For NCTM, the approval of a brand new NCTM is not required because it is not used for trade purposes.
- The re-verification of NCTM is done only when there is a dispute from the client about the health of the flow meter (over and under registered, etc.).

NML – SIRIM BERHAD

Implementation Problem in Malaysia



- For CTM, the implementation of legal metrology system is easier because the clients have awareness on the legal metrology requirements.
- For NCTM, the implementation of legal metrology system is not required because it is used for internal process and monitoring purposes.
- The authorized agency, MDTCC also lack of awareness about the legal metrology system. Some of CTM installed in Malaysia do not have pattern approval from NML-SIRIM Berhad.
- No verification is done on the NCTM in Malaysia.
- The verification of NCTM is done after there is a request from client. Normally the NCTM will be sent to NML-SIRIM Berhad or other accredited laboratories for calibration.

NML – SIRIM BERHAD

Implementation Problem in Malaysia



- The main reason for the difficulty in implementing the legal metrology system in Malaysia is due to :
- i) lack of awareness from authorized agency
- ii) lack of awareness from clients

NML – SIRIM BERHAD

MALAYSIA : Economy Report



**Presentation by
Mr Julian Crane**
Measurement and Product Safety
Service (MAPSS)
Ministry of Consumer Affairs
New Zealand

Organisation

- MAPSS has 10 field Inspectors looking after a population of 4 million people.
- Verification and Certification of weighing and measuring equipment in NZ is conducted by private organisations accredited to do the testing, they are called "Accredited Persons".
- There are 49 companies accredited which are made up of 296 individuals, each Individual is accredited.
- As well as administering the Accreditation Scheme MAPSS conducts Investigations into complaints under the Weights and Measures Act and Product Safety.

Personal Experience

- I have worked as an Inspector of Weights and measures for 24 years
- 17025 Laboratory accredited Signatory for mass and volume calibrations
- Approvals testing (mainly high capacity and unique equipment in-situ)
- Training Co-ordinator

Mass Flowmeters used in NZ

- MFMs are relatively new technology in NZ
- First verification was only 12 yrs ago
- 2 main makes
- Micro Motion
- Rotomass
- 9 installations verified for trade use, more in non-trade applications
- Mainly used for hydrocarbons eg: Bitumen diesel, kerosene and adhesion agents

Legal Metrology System

- Mass flow meters must have been tested and approved to OIML R117 before they can be Verified for trade use in NZ
- NZ cannot test to R117 so we rely on certificates issued by OIML approved test authorities for certification
- The NZ Weights and Measures Act and Regulations prescribes some minimum test requirements

Sample of Regulation 74

- *Direct Mass Flow Measuring Instruments*
- **74 Direct mass flow measuring instruments**
- (1) This regulation applies to direct mass flow measuring instruments.
- (2) Unless any of subclauses (3), (4), and (5) apply, the maximum amount of error, in excess or deficiency, permitted on the verification and inspection of a direct mass flow measuring instrument may be up to and including 0.5% of the quantity measured by that instrument if—
 - (a) That quantity is equal to, or greater than the minimum quantity to be measured as specified by that instrument's manufacturer, and
 - (b) That quantity is measured at a temperature or pressure within the range specified in the approval, given in accordance with regulation 5, for that instrument.
- (3) If the quantity measured is between the minimum quantity to be measured as specified by the manufacturer and twice that quantity, the maximum amount of error, in excess or deficiency, may be up to and including 1.0% of the minimum quantity.
- (4) Where a series of tests is conducted on an instrument, the difference between the largest amount of error and the smallest amount of error must be no greater than 0.2% of the quantity measured during testing.
- (5) If the instrument is used to measure liquefied gas, the maximum amount of error, in excess or deficiency, permitted on the verification and inspection of that instrument is 1.0% of the quantity measured by that instrument, if that quantity is equal to or greater than the minimum quantity to be measured as specified by that instrument's manufacturer.

Compliance

- Verification and Certification testing is carried out using the minimum requirements of the Weights and Measures Act and Regulations
- Where the requirements are not specific enough for testing we adopt the relevant parts from R117 and best international practice
- Up until recently all testing has been conducted by MAPSS Inspectors, there is now 1 company accredited to perform verifications on MFM's

Issues post Workshop

- NZ will develop more comprehensive test procedures that incorporate R117 recommendations and best international practice
- Those test procedures will be used for:
 1. Inspectors conducting approval and variant tests
 2. Inspectors up skilling their knowledge for conducting audits and surveillance on accredited persons
 3. Assisting Accredited Persons to develop Verification test procedures that comply with the legal requirements and recommendations

TRAINING COURSE ON Mass Flow Meter SINGAPORE

ECONOMY: PERU

ORGANIZATION: INDECOPI

NATIONAL METROLOGY SERVICE

TRAINEE: Nikko Meza



Asia-Pacific
Legal Metrology Forum



Asia-Pacific
Economic Cooperation

LOCATION

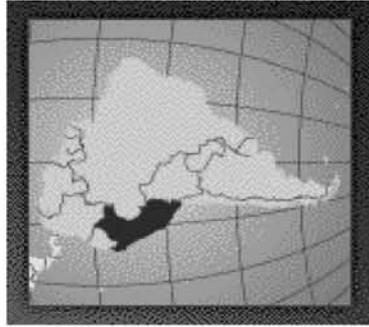

PERU IS PART OF
LATIN AMERICA.
IT IS LOCATED IN
THE OCCIDENTAL
PART OF SOUTH
AMERICA.

Peru is the land of the INCAS Empire



INFORMATION

- Economy (long form): Republic of Peru
- Capital: Lima
- Total Area: 1 285 215 square kilometers
- Population: 29 132 032
- Languages: Spanish (official), Quechua (official), Aymara
- Religions: Christians (Catholic and others) 99 %
- Government Type: Constitutional Republic
- Currency: 1 Nuevo Sol (S/.) = 0,30 US\$
- Industry: mining of metals, petroleum, fishing, textiles, clothing, food processing, cement, steel, metal fabrication
- Agriculture: coffee, cotton, sugarcane, rice, wheat, potatoes, coca; poultry, beef, dairy products
- Peru has the biggest biodiversity of the world
- Natural Resources copper, silver, gold, petroleum, wood, fish and others



INTRODUCTION



INDECOPi

- Explain about your organization and department?
- INDECOPi was created by Law N° 25868 in November 1992, to promote a culture of loyalty and fair competition in the Peruvian Economy and to protect all forms of intellectual property: from copyrights to patents and biotechnology.



Asia-Pacific Economic Cooperation



INTRODUCCION

The **NATIONAL METROLOGY SERVICE** was created in 1983 to promote the development of metrology in Peru and to contribute to the spreading of the units of the SI. Currently it is the only entity in Peru capable of offering a reliable service of metrological assurance, which is necessary for institutions looking for a quality system, and subsequently getting recognition through of the International System Organization (ISO).



INTRODUCTION

- Explain your professional experience in your organization?
I am technical metrologist of Volume and Density laboratory in National Metrology Service — INDECOPi. I'm making the calibrations service of Standard Test Measure, water meter, flow meter.



2_Mass Flow Meter used in your economy

The mass flow meters used in my economy are the Coriolis flow meters. These meters are used as standards to calibrate the LPG and CNG dispensers.

3_ Legal Metrology System for mass flow meter in your economy.

There is no Legal Metrology System for mass flow meters in my economy.

4_ Explain current situation in your economy about the complice to the international standards / recommendations for mass flow meter.

In my economy, currently does not apply any standar / international recommendation for mass flow meters.

5_ Are there any other requirements from your economy? Do you have any problems in order to implement the legal metrology system (budget; humans resources, etc.)?

To implement the system of legal metrology, we needs greater regulation and then increased budget and human resources.

Thank you!

Nikko Meza Valencia

INDECOPi - PERU

nmeza@indecopi.gob.pe



Asia-Pacific
Legal Metrology Forum



Asia-Pacific
Economic Cooperation

Overview of the Legal Metrology System on Mass Flow Meter in the Philippines

July 6-9, 2010
Holiday Inn Atrium, Singapore

I am Marilyn C. Fos, Senior Science Research Specialist working at the Density Viscosity, Moisture, Volume and Flow Standards Section of the National Metrology Laboratory (NML) of the Industrial Technology Development Institute (ITDI) an agency under the Department of Science and Technology (DOST)

I have already spent 20 years in government service, 19 years of which in Metrology.

The ORGANIZATION of DOST

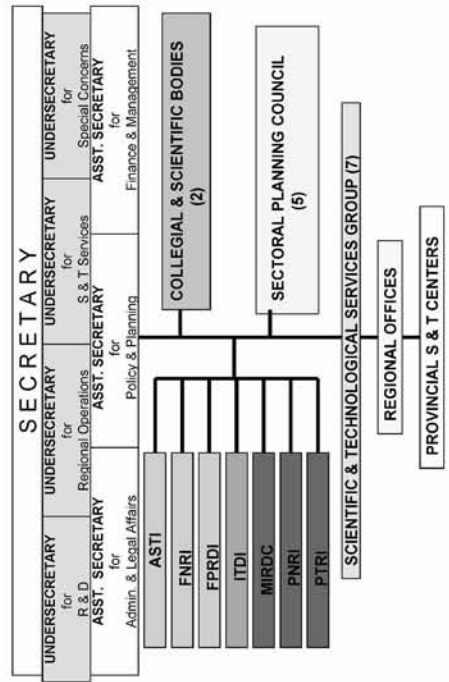

The New ITDI Organisational Chart

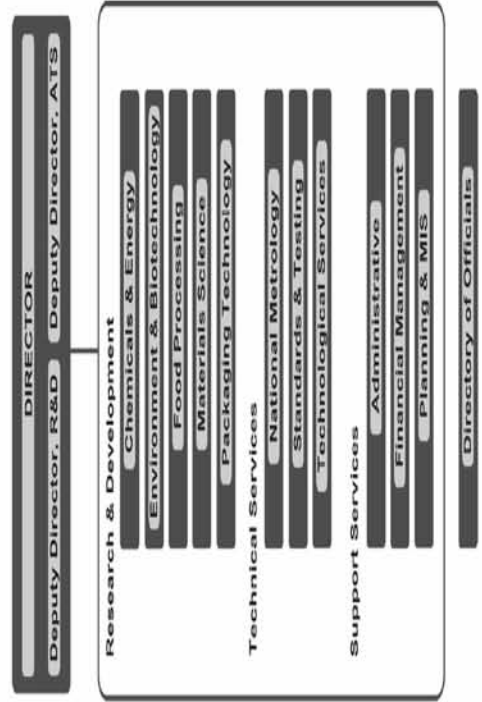

The National Metrology Laboratory —Philippines



NML Goal— Provide accurate international traceability of the physical measurements undertaken in the country.

The National Metrology Laboratory (NML) is tasked to establish, develop and maintained the national standards of measurement (scientific metrology). In addition to this task, the NML leads together with other regulatory agencies in the implementation of the legal metrology services and provides industrial metrology services to manufacturing industries.

Brief History:

The Industrial Technology Development Institute (ITDI), a government organization under the Department of Science and Technology (DOST), is a multi-disciplinary research and technical service institute. It is mandated by virtue of Executive Order No. 128 to render various services to local industries.

National Metrology Laboratory

MISSION—*To establish and disseminate national standards of units and measurements to calibration laboratories and other sectors to provide international traceability to measurements done in the country by reliably conducting calibration and measurements at accuracy levels appropriate to the needs of the clients.*

The NMLPhil Organizational Structure

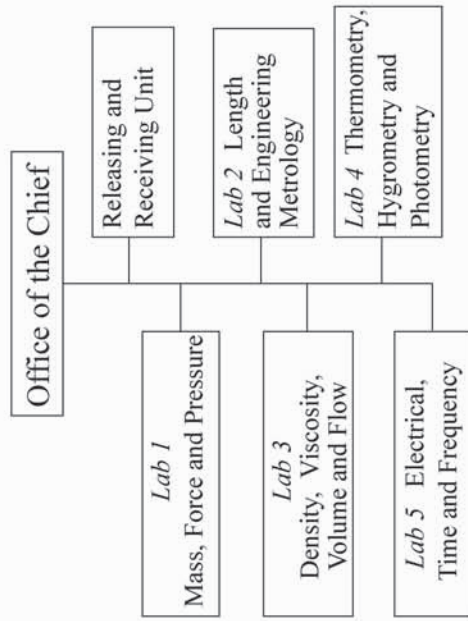

NMLPhil Laboratories



NMLPhil Laboratories



NMLPhil New Photometry Laboratory

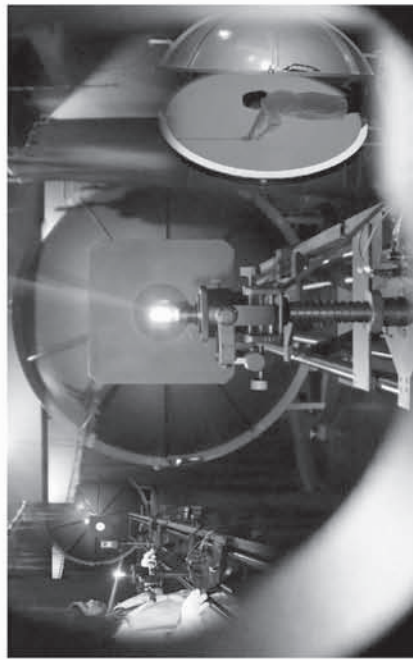

Description of Specific Activity

1. Conducts in house and on site Calibration/Verification for Density, Viscosity , Volume and Flow Measuring Instruments.
2. Technical trainer and consultant in the fields of Density, Viscosity, Volume and Moisture.
3. Participated in the International Laboratory Comparison in the fields of Density Measurements.
4. Technical Assessor for Philippine National Standards in the field of Volume.

Mass Flow Meters used in the Philippines

- a. Positive Displacement meter for fuels
- b. LPG gas meter
- c. Mass flow meters for different fluids

Legal Metrology System for Mass Flow Meters in the Philippines

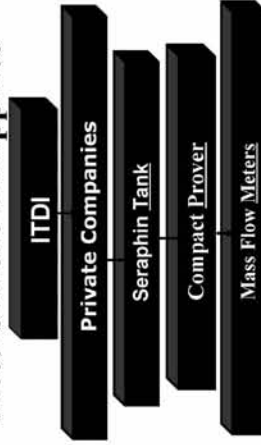

Fuel companies like Petron Refinery are submitting their mass flow meters for calibration to check their meters accuracy and to deliver good quality service to their customers. Other companies submit their mass flow meters to private calibration laboratories or sent abroad for calibration.

On Site Calibration of Mass Flow Meters



Current situation in the Philippines about the compliance to the International standards/recommendations for mass flow meters.

We are on the process of setting up mass flow meter calibration facilities. Many utility companies have set-up their own coriolis metering systems for different fluids involved, e.g. water, gas, LPG, CNG and other petroleum products. Some private Institutions have already established their own calibration laboratories.

DOST REGIONAL CALIBRATION LABORATORIES

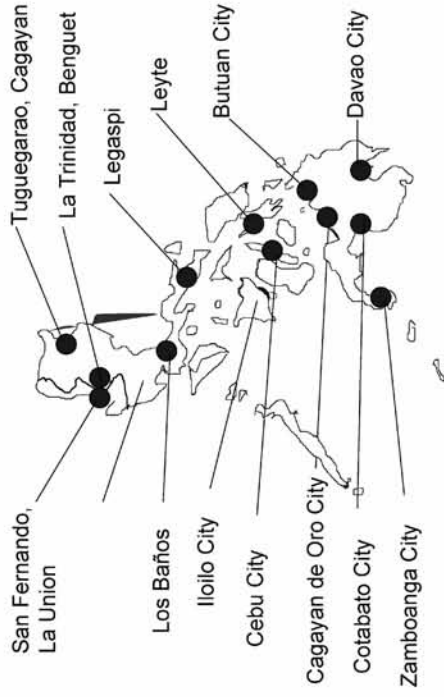

Being the Philippine NMI, the NML, ITDI has to keep abreast of advances/developments in Science and Technology to continually provide highly accurate and reliable metrology and calibration services to industry and for the benefit of all concerned.

Furthermore, technical expertise of NML staffs are gained through trainings provided by foreign NMIs abroad and this expertise are shared with other laboratories or companies in need of metrology trainings after they return.

THE PHILIPPINE ISLANDS

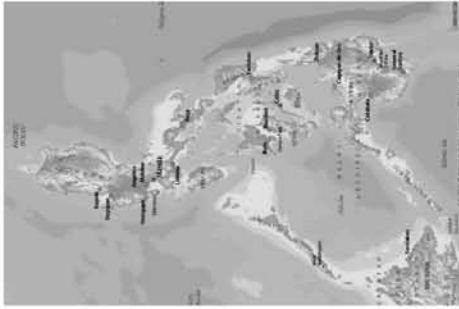

An archipelago of approximately 7,107 islands, the Philippines stretches from the south of China to the northern tip of Borneo. The country has over a hundred ethnic groups and a mixture of foreign influences which have molded a unique Filipino culture

Total Land Area: 115,600 sq. miles / 299,404 sq. kms

Capital City: MANILA

Population: approximately 92 million people

Philippine Destinations



Banaue—This majestic man-made wonder looks like a giant stairway leading to the sky.

Philippine Destinations

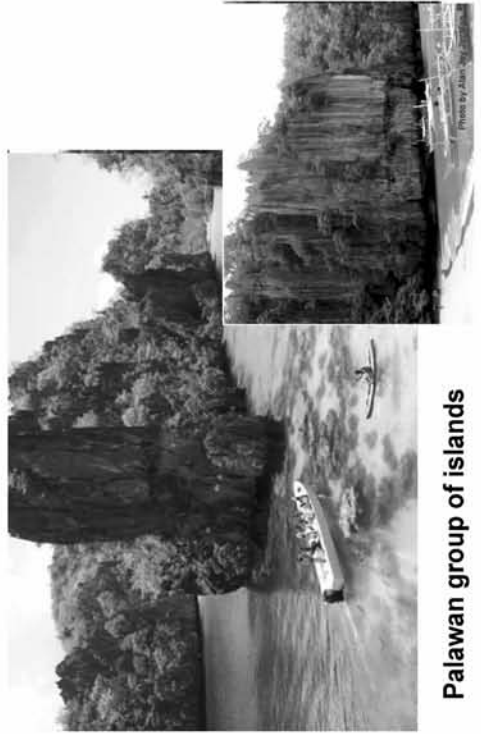

Palawan group of islands

Philippine Destinations

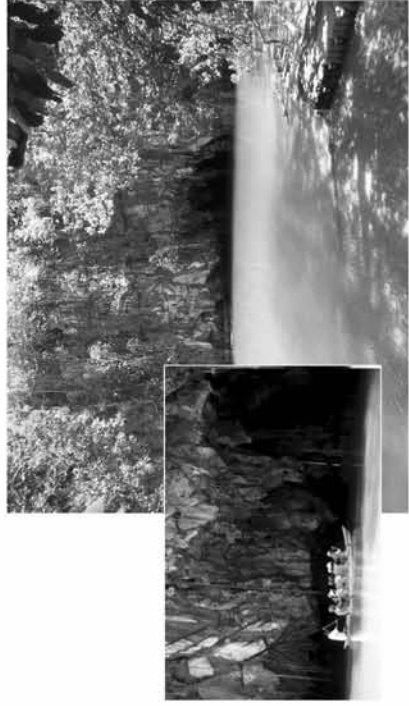

The Underground River or Subterranean River National Park of Puerto Prinsesa is now one of the New 7 Wonders of the World

Philippine Destinations

Hundred Islands

—This National Park covers a land area of 1,884 hectares with 123 islands.



Thank You!!!

NML Staff



Graduated Neck type Vessel 250L

Gravimetric Method

Weighing Comparator, 600 Kg Capacity
readability 0.1 g

Traceable to ITDI's Mass Standards
set of weights KRISS KOREA OIML Class E2

Back page

Calibrated to deliver using the stainless 250 L graduated neck type vessel.

Back page

The Coriolis Flow Meter is calibrated using Volumetric Method in which the meter was compared to the Standard Compact Prover.

Relevant standards, e.g. API, ASTM, OIML, Manufacturer's manual and Technical literature, and/or procedures followed in the proving and operation of the meter/system.

The meter will be tested and re-certified every six months until such time that the Trend Chart shows consistent proving results which would possibly extend re-calibration interval to one year.

The repeatability of proving results should be within 0.025% while the meter factor reproducibility between provings is within $\pm 0.25\%$.

Back page



APEC/APL MF Seminar and Trainer Course in Legal Metrology – Mass Flow Meter

Presented by
Lim Yong Seng
Inspector, Weights and Measures Office (WMO)
SPRING Singapore
6 July 2010

SPRING
singapore

Outline

1. Singapore Weights and Measures Programme
2. Activities of WMO, SPRING Singapore
3. Legal Metrology Requirements for Mass Flow Meter
4. Next Steps

The Weights and Measures Programme

- Governed by the Weights and Measures Act & Regulations
 - regulates weighing and measuring instruments for trade use and net contents of pre-packaged goods
 - penalises suppliers on short weights and measures
- Ensures a uniform and accurate system of weights and measures so that buyers get what they paid for
- Ensures fair trade and correct excise tax computation

Activities of WMO

Manages Authorised Verifier (AV) Scheme



- Weights and Measures Act and Regulations were amended in Dec 2005, allowing SPRING Singapore to designate AVs.
- AV Scheme took effect from 1 Jan 2006. From 1 Jan 2009, 100% verification work is undertaken by AVs.
- To date, 22 AVs have been designated.
- The AV Scheme increases the pool of verifiers resulting in lower cost and reduced turnaround time for businesses.

Activities of WMO

Registers patterns of new instruments for trade use

- All patterns of new weighing and measuring instruments for trade use have to be tested and certified to meet the applicable OIML Recommendation e.g. Flow Meter to OIML R117.
- This is to ensure that they are designed to be robust and can maintain their accuracy under different climatic and operating conditions.
- To date, over 250 patterns of weighing and measuring instruments have been registered with SPRING Singapore for trade use.



Activities of WMO

Administers the Accuracy Label



- To further boost the confidence of consumers and businesses alike, Accuracy Labels (above) are affixed on all verified weighing and measuring instruments for trade use.
- Contain AV's identification code, eg, "01", "02" and date of verification.
- All 40,000 weighing and measuring instruments for trade use are affixed with the Accuracy Label.

Activities of WMO

Post-market Surveillance and Audit Inspections

- Inspects weighing and measuring instruments for inaccuracies & tampering
- Conducts audit reviews on Authorised Verifiers
- Investigates complaints on short weights & measures

Legal Metrology Requirements for Mass Flow Meter

Metrology Control

- > Flow meters should be pattern evaluated to the relevant international standard (ie. OIML R117) and is subject to SPRING's approval and registration prior to trade use.
- > Registered flow meters meant for trade use/custody transfer are also required to be verified and stamped with the weights and measures seal.
- > Verification and stamping are conducted by SPRING's designated AVs and annual re-verification is recommended.
- > SPRING introduced the Recognised Testing Laboratory (RTL) Scheme in 2009 to supplement the measuring capability of the AVs. The RTL Scheme allows SPRING to accept test report from the RTLs.

Next Steps

1. Expand the scope of the Authorised Verifiers to include new areas like verification of CNG dispensers, working standards, etc.
2. Develop verification capabilities in emerging areas such as Hydrogen Dispensers
3. Equip WMO Inspectors/Authorised Verifiers with latest updates on relevant OIML Recommendations

Thank You

APEC/APLPMF Seminars and Training Courses in Legal Metrology
 Strengthening Legal Metrology Infrastructure for Trade Facilitation:
 Mass Flow Meter (CTI 46 09T)
 July 6 - 9, 2010

PRESENTED BY:
 Khemsai Rahannok
 Central Bureau of Weights and Measures (CBWM)
 Department of Internal Trade, Ministry of Commerce
 THAILAND

1. Brief Introduction of Central bureau of Weights and Measures (CBWM)

The Structure

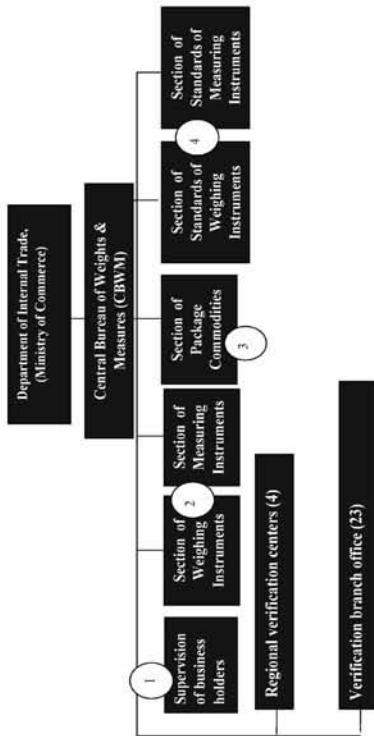

1. Brief Introduction of Central bureau of Weights and Measures (CBWM)

The duties and responsibilities of CBWM are mainly divided into 4 categories as follows:

1. *Supervision of Business Holder : manufacturers, importers, repairers and sellers of weights and measures instruments.*
2. *Establishing the standards of weighing and measuring instruments.*
3. *Providing verification services for weighing and measuring instruments.*
4. *Prescribing the displaying method of net content of packaged goods and inspecting the net content of packaged goods for the impartiality of the commodity transaction.*

Also function is develop/improving the law and ministerial regulation of weights and measures to be in conformity with international standard.

2. Mass flow meter used in Thailand

- ❖ *Most of mass flow meter take to used at the service natural gas station (NGV) and some part of the petrochemical.*
- ❖ *There are currently 373 serviced NGV stations in Thailand which there is the NGV gas dispenser approximately 3,760 units. (May 2010).*



3. Legal metrology system for mass flow meters in Thailand

➤ *Weights & Measures Act B.E.2542 has come into force since 1999. The Ministerial Regulations that issue under this Act to supervise the use of weights and measures instrument are following :*

- *Non-Automatic Weighing*
- *Automatic Weighing Instruments*
- *Standard Weights*
- *Length-measurement Instruments*
- *Automatic Level Gauges*
- *Liquid-measurement Instruments*
- *Water Meter*
- *Gas Volume Meters*
- *Mass Flow Meters*
- *Package commodities*
- *Etc.*

(2) *Repeatability test shall be equal or less than 0.8% of the test quantity.*

(3) *The term of verification for the mass flow meter : Mass flow meter shall be examined and verified every 2 years.*



➤ *The Ministerial Regulation to supervise the use of the mass flow meters in Thailand has come into force since October 5, 2009. The verification carried out as follows :*

(1) *Maximum permissible errors for the initial verification and the re-verification given in the table :*

Quantity (M) (kg)	Maximum permissible errors
0.1 to 0.2	0.08 M
0.2 to 0.4	16g
0.4 to 1	0.04M
1 to 2	40g
Not less than 2	0.02M

***The permissible errors + 2%
(not less than 2 kg)***

4. **Current situation in Thailand about the compliance to the international standard/recommendations for mass flow meter**

- ❖ *The current situation the compliance of National Institute of Standards and Technology (NIST)*
 - *Handbook 44-2008*
 - *Section 3.37 Mass Flow Meter*

Determination

$$\text{Formula} = \frac{\text{standard scale} - \text{display}}{\text{Standard scale}} \times 100\%$$

Example @ 20 kg

$$= \frac{20.2 - 20.0}{20.2} \times 100\% = 0.99\%$$

5. The other requirements / any problem

- (1) The specialization :*
- (2) The staffs and budget :*

**Thank you very much
for your attention**



APEC/APLMF SEMINAR AND TRAINING COURSES
IN LEGAL METROLOGY
(GT1 46 09T)

**Strengthening Legal Metrology
Infrastructure for Trade Facilitation:**

Mass Flow Meter

July 6–9, 2010
at the Holiday Inn Atrium,
Singapore



VIETNAMESE REPORT

Presenter : Nguyen Hoang Nam
Volume and Flow Laboratory
VIETNAM METROLOGY INSTITUTE —VMI

SELF INTRODUCTION

- My name: Nguyen Hoang Nam
- From: Viet Nam Metrology Institute (VMI) www.vmi.gov.vn
- Position and Responsibility :
 - Volume and flow laboratory
 - Testing and verifying for volume and flow measurement equipments, such as flow meters, gas meter ...

EXPERIENCE

- fuel oil flow meter for petrol
 - Manufacture: Japan, USA, Germany, China...
 - Class: 0.5
 - Flow rate:(0,5~300) m³/h
- I have verify experience about mass flow meter in Viet Nam

Using of CNG in Viet Nam

- Mass flow meter is used in custody transfer systems
- Mass flow meter is used as transfer standard

VIET NAM'S LEGAL METROLOGY SYSTEM

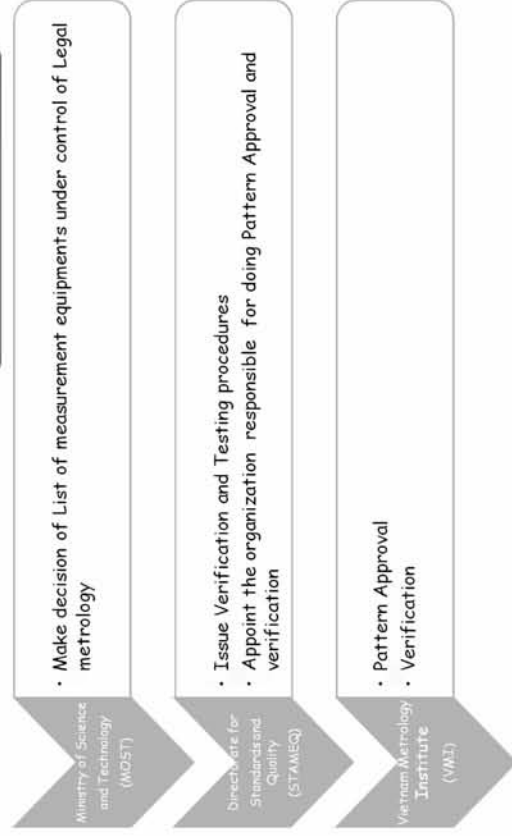

MY PURPOSE

- Getting legal metrological control on Mass flow such as regulations, type approval, verification ...
- Prevailing of Mass flow meter in the near future because :
 - High accuracy
 - Easy to user
 - Convenience of control system

PROBLEMS

Lack of one

- procedures for testing and verification of the Mass flow meters in Viet Nam
- human resource
- equipment for testing and verification of Mass meters

Thank You !